

N

NORGESTONE  
essential surfaces

Made in Italy



NovaBell



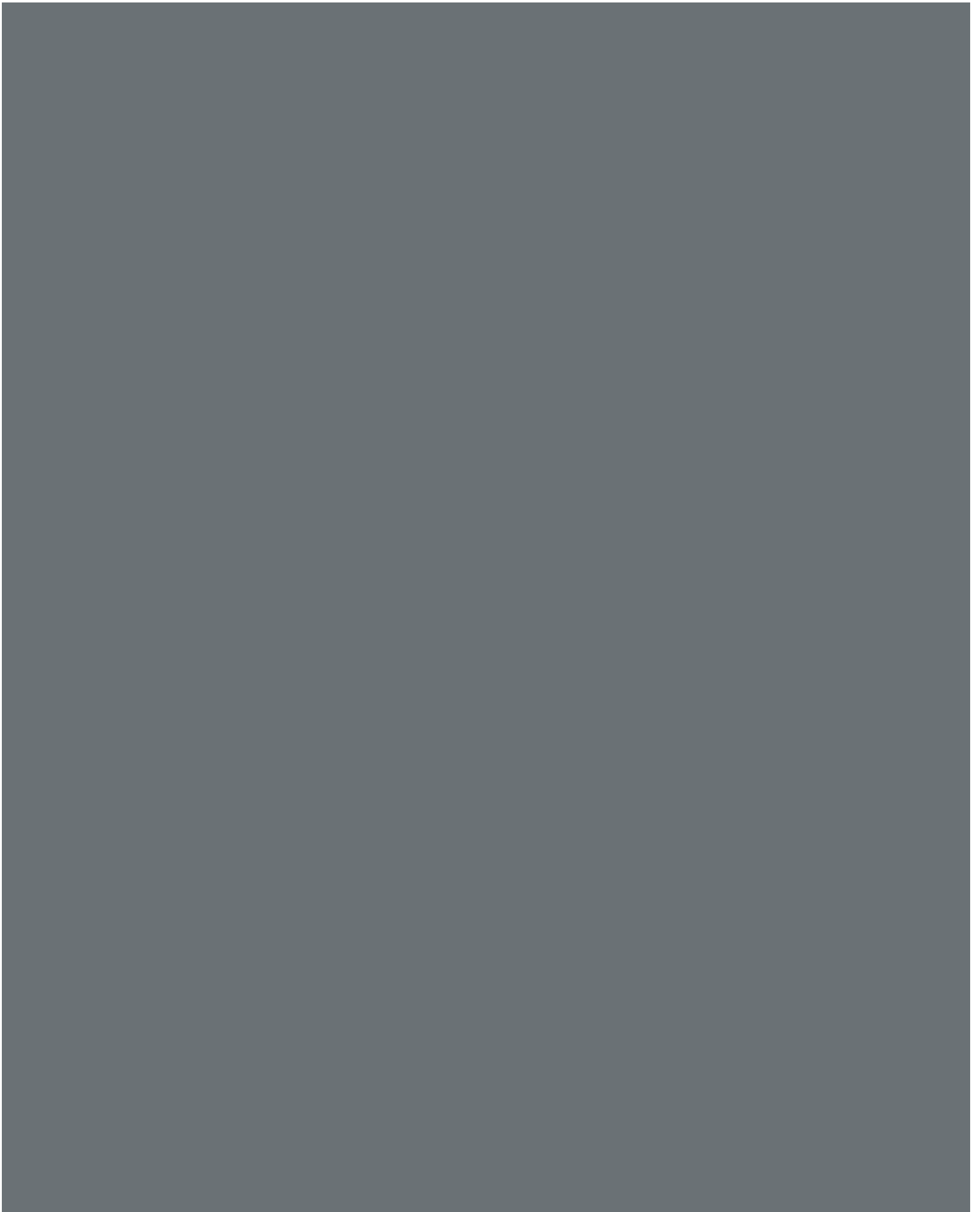



# NORGESTONE

Attraverso la profonda ricerca di **straordinarie pietre provenienti dal Nord Europa** nasce **Norgestone**, il gres porcellanato NovaBell che consegna all'architettura contemporanea **un intenso progetto di superfici essenziali ed equilibrate.**

---

In-depth research into the **amazing stones from Northern Europe** gives us **Norgestone**, the NovaBell porcelain stoneware that offers contemporary architecture **a collection of simple, tasteful yet high-impact surfaces.**

#### Surface essentielle

C'est d'une minutieuse recherche parmi les **pierres extraordinaires de l'Europe du Nord** que provient **Norgestone**, le grès cérame NovaBell qui offre à l'architecture contemporaine **un grand projet de surfaces essentielles et harmonieuses.**

#### Minimalistische Oberflächen

Eindrucksvolle **Natursteinarten aus dem nordeuropäischen Raum** sind der Ausgangspunkt für die Entwicklung von **Norgestone**, einem **umfangreichen Feinsteinzeug-Projekt** aus dem Hause NovaBell mit **sachlich-harmonischen Oberflächen** für die moderne Architektur.

- IN&OUT: NORGESTONE KNOWS NO BOUNDARIES -

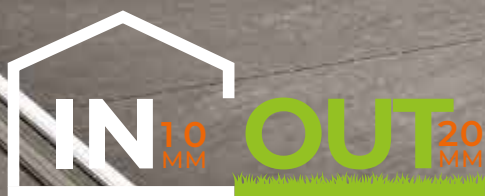



**Norgestone legge l'outdoor come naturale prolungamento dello spazio interno.**  
Per questo motivo i **movimenti di superficie, naturali e misurati**, sono progettati per ottenere una perfetta coordinazione cromatica e una precisa comunicazione in&out.

---

**Norgestone views the outdoors as the natural extension of indoor space.** Therefore, its **subtle, naturally varied surfaces** are designed to achieve perfect colour matching and clear communication between indoor and outdoor areas.

**In&out : Norgestone ne connaît aucune limite**  
**Pour Norgestone, l'extérieur est le prolongement naturel de l'espace intérieur.**  
Les **mouvements de surface, naturels et modérés**, sont d'ailleurs conçus pour atteindre une coordination parfaite entre les couleurs, ainsi qu'une communication claire entre intérieur et extérieur.

**In&out: Norgestone ist grenzenlos**  
**Für Norgestone ist der Außenbereich die natürliche Verlängerung des Innenbereichs.**  
Deshalb ist die **Dynamik der natürlichen, zurückhaltenden Oberflächen** auf die perfekte Farbabstimmung und eine akkurate optische Einheit von Indoor und Outdoor ausgerichtet.

- COLOURS IN HARMONY WITH SPACE -

IVORY

TAUPE

LIGHT GREY

DARK GREY

SLATE



Le 5 nuance Norgestone possiedono **toni e grafiche incredibilmente bilanciati**, l'unione tra la ricca gamma di formati e la naturalezza cromatica, trasferisce agli spazi un **effetto d'insieme unico, accogliente e organico**.

---

The **tones and patterning** of the 5 Norgestone colour shades **strike wonderful harmonies**, and the combination of the large assortment of tile sizes and the natural beauty of the colours gives interiors a **unique, welcoming, organic unity**.

#### Les couleurs en harmonie avec l'espace

Les cinq nuances Norgestone affichent des **tonalités et des textures graphiques équilibrées à merveille**. L'union entre la grande variété des formats et le naturel des couleurs donne à l'espace un **effet d'ensemble unique, accueillant et harmonieux**.

#### Farbliche Raumharmonie

**Farbtöne und Muster** der 5 Farbnuancen von Norgestone strahlen eine **unglaubliche Harmonie** aus. Die gelungene Verbindung von vielfältigem Formatangebot und farblicher Natürlichkeit verleiht den Räumen eine **besonders wohnliche, abgerundete Gesamtwirkung**.

Norgestone possiede due caratteristiche fondamentali: un'estetica autenticamente bella e un'articolata gamma che risolve la coordinazione tra interno ed esterno.

**Dai fondi planari fino ai moduli spessorati da esterno, NovaBell costruisce un ricco catalogo di superfici dedicate al progetto architettonico contemporaneo.**

Norgestone has two fundamental characteristics: a genuinely beautiful appearance and an extensive range that enables you to coordinate indoors and outdoors.

**From flat plain tiles to extra-thick outdoor modules, NovaBell offers a rich catalogue of surfaces dedicated to contemporary architectural design.**

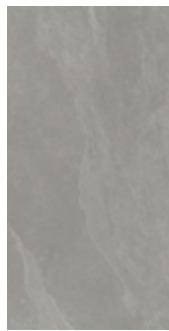

**60x120**  
23<sup>5/8</sup>x47<sup>1/4</sup>



**30x120**  
11<sup>13/16</sup>x47<sup>1/4</sup>



**60x60**  
23<sup>5/8</sup>x23<sup>5/8</sup>



**30x60**  
11<sup>13/16</sup>x23<sup>5/8</sup>



**80x80**  
31<sup>1/2</sup>x31<sup>1/2</sup>

### Struttura Cesello



**60x120**  
23<sup>5/8</sup>x47<sup>1/4</sup>



**30x120**  
11<sup>13/16</sup>x47<sup>1/4</sup>



**30x60**  
11<sup>13/16</sup>x23<sup>5/8</sup>



Norgestone possède deux atouts fondamentaux : une beauté authentique et une collection complète pour coordonner intérieur et extérieur.  
**Finitions lisses ou modules ultra épais pour extérieur, NovaBell construit un riche catalogue de surfaces pour l'architecture contemporaine.**

Norgestone besitzt zwei grundlegende Eigenschaften: eine natürlich schöne Optik und ein vielfältiges Sortiment für eine abgestimmte Einheitlichkeit zwischen Innen- und Außenbereich.  
**Von ebenflächigen Grundfliesen bis zu überstarken Modulen für den Außenbereich bietet NovaBell eine reiche Auswahl an Oberflächen für moderne Architekturprojekte.**



**OUT  
WALK**

**20**  
Porcelain  
slabs

20 mm



**60x180x2**  
23<sup>5/8</sup>x70<sup>7/8</sup>x3/4"



**60x120x2**  
23<sup>5/8</sup>x47<sup>1/4</sup>x3/4"



**60x90x2**  
23<sup>5/8</sup>x35<sup>7/16</sup>x3/4"



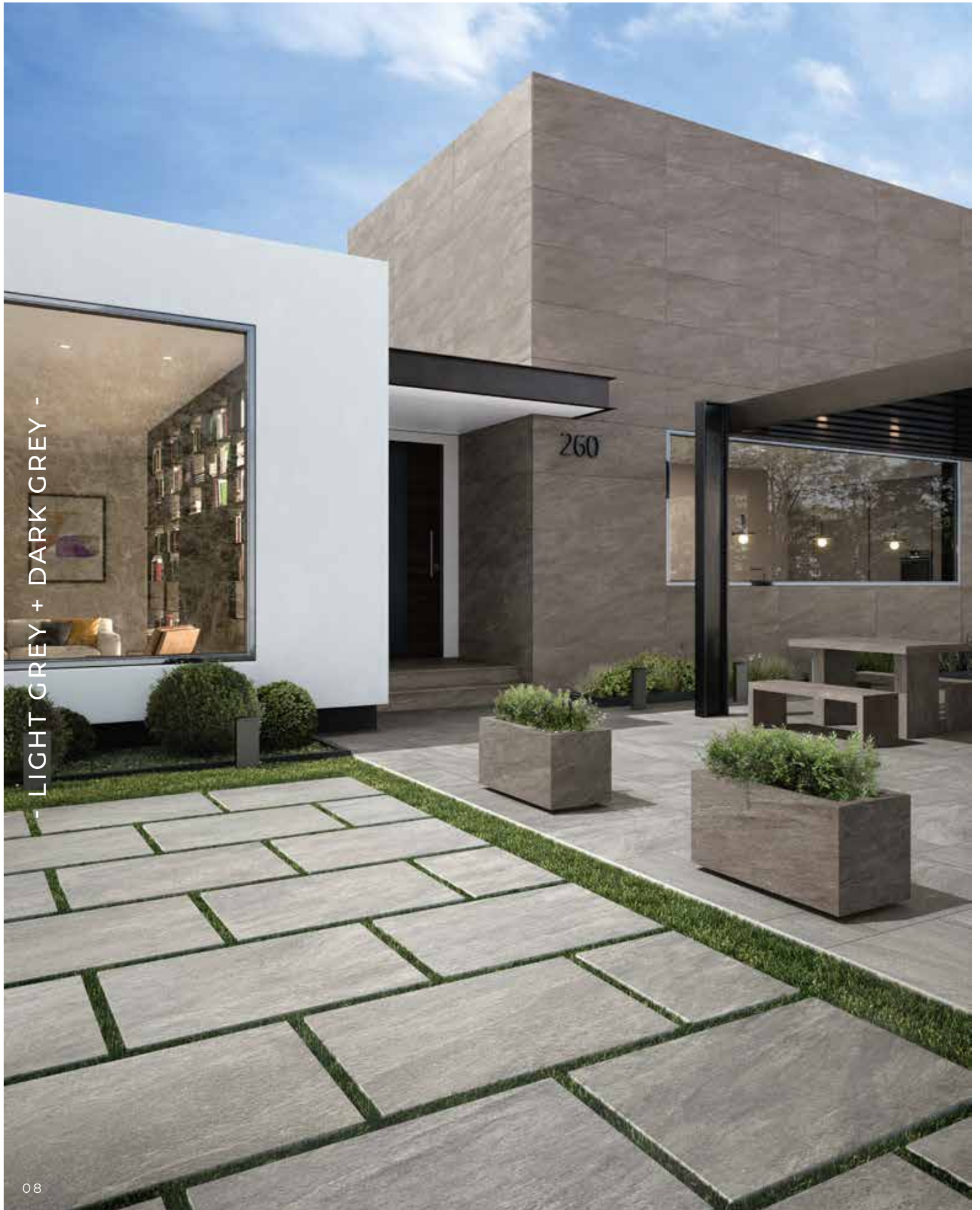

- LIGHT GREY + DARK GREY -



Il progetto di superfici in **spessore 20 mm OutWalk 20**, coordina i progetti outdoor e gardening con la **sicurezza del gres porcellanato ad alte prestazioni NovaBell**. Norgestone completa con precisione e sicurezza tutti gli spazi esterni.

The **OutWalk 20** collection of surfaces **20 mm thick** offers the basis for outdoor and garden design projects with the **safety of porcelain stoneware and the excellent performances of NovaBell**. Norgestone completes all outdoor spaces with precision and safety.



**OutWalk 20 : haute performance et beauté**  
Le projet des surfaces **OutWalk 20 de 20 mm d'épaisseur** coordonne les projets d'extérieur et de jardinage avec la **sécurité du grès cérame haute performance NovaBell**. Norgestone est la touche finale précise et sûre dans tous les espaces extérieurs.

**OutWalk 20: Hohe Leistungen und vollendete Ästhetik**  
**OutWalk 20**, das Projekt für Oberflächen mit **20 mm Stärke**, bietet die Verbindung von Outdoor- und Gardening-Projekten mit der **Sicherheit, die ein hochbeständiges Feinsteinzeug von NovaBell bietet**.  
Mit Norgestone lassen sich Außenbereiche optisch ansprechend und sicher gestalten.

NovaBell progetta moduli che moltiplicano le possibilità compositive. Attraverso il taglio delle grandi lastre 60x180x2 cm, sono disponibili **mix di formati imballati e pronti all'uso.**

NovaBell designs modules that multiply compositional possibilities. The large 60x180x2 cm slabs can be cut to create a **mix of sizes that are packaged and ready for use.**

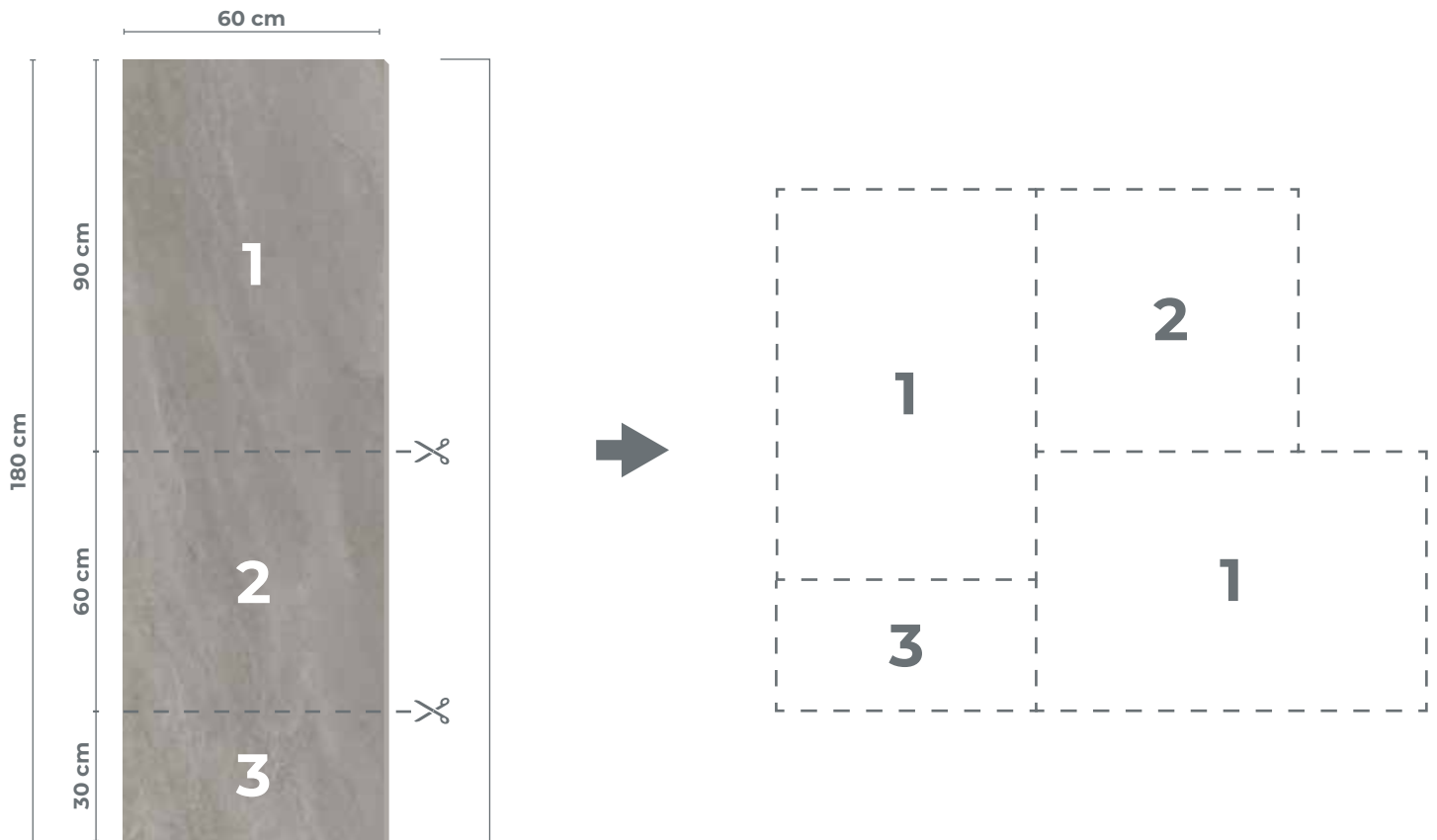

NovaBell crée des modules qui affranchissent la liberté de composition. Des coupes sont réalisées à partir des grandes dalles 60x180x2 cm pour former un **mélange de formats emballés et prêts à l'emploi.**

NovaBell entwickelt Module, die die Kompositionsmöglichkeiten vervielfachen. Aus dem Schnitt von Platten im Großformat 60x180x2 cm werden **Formatmixe** zusammengestellt, die **verpackt und gebrauchsfertig** erhältlich sind.



- OUTWALK 20: OUTSTANDING PERFORMANCE AND BEAUTY -

Easy to install



Colours that never fade



1

2

3

Norgestone est une matière multifonctionnelle et éclectique. **Les dalles OutWalk 20 peuvent être façonnées sur demande pour réaliser des projets d'ameublement, des marches et des margelles de piscine en coordination totale avec le reste des surfaces.**

Le grès cérame NovaBell peut se targuer d'exceptionnelles propriétés techniques et fonctionnelles, de couleurs inaltérables, d'une grande facilité de pose et d'entretien.

Norgestone ist ein multifunktionelles, vielseitig einsetzbares Material. **Die OutWalk 20 Platten können auf Wunsch für die Gestaltung von Einrichtungselementen, Stufen und Barfußbereichen in Schwimmbädern verarbeitet werden, die absolut perfekt auf die übrigen Oberflächen abgestimmt sind.** Das NovaBell Feinsteinzeug besitzt unschlagbare technische Leistungsmerkmale, ist farbecht sowie verlege- und reinigungsfreundlich.

Norgestone è una materia multifunzionale e versatile.

**Le lastre *OutWalk 20* possono essere lavorate su richiesta per la progettazione di complementi d'arredo, gradini e bordi piscina in totale coordinazione con il resto delle superfici.**

Il gres porcellanato NovaBell possiede prerogative tecnico-funzionali imbattibili, colori inalterabili, è facile da posare e da pulire.

Norgestone is a multifunction, versatile material.

***OutWalk 20* slabs can be shaped to order for the design of furnishings, steps and pool edges that totally match with the rest of the surfaces.**

NovaBell porcelain stoneware has unbeatable technical and functional qualities and colours that never fade. It is also easy to install and clean.



### Bordo piscina con gradino monografico.

Pool edge with monographic step.

Margelle de piscine avec marche monographique.

Barfußbereiche in Schwimmbädern mit monografischer Stufe.

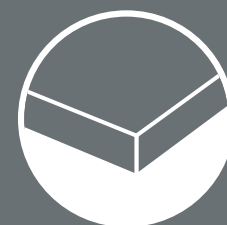

1

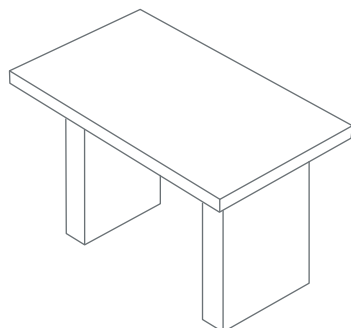

**120x80x75h** 47<sup>1/4</sup>x31<sup>1/2</sup>x29<sup>1/2</sup>  
**TAV2CM2**

2

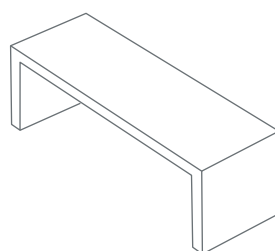

**40x120x40h** 15<sup>3/4</sup>x47<sup>1/4</sup>x15<sup>3/4</sup>  
**PANK2CM1**

3

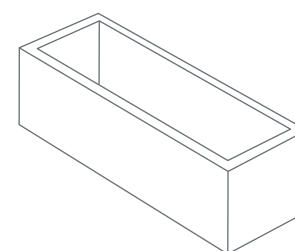

**120x40x40h** 47<sup>1/4</sup>x15<sup>3/4</sup>x15<sup>3/4</sup>  
**FIO2CM1**

Le scale sono spesso vere e proprie protagoniste dell'architettura e la spina dorsale dello spazio; per questa ragione NovaBell ha progettato elementi ceramici capaci di modellarsi con estrema precisione e rigore.

**I gradini con larghezza 120 cm sono perfezionati in ogni dettaglio e possiedono vantaggi impareggiabili: completano le pavimentazioni facilitando la messa in opera sul massetto, sono coordinati al resto delle superfici e le loro dimensioni corrispondono agli standard progettuali.**

---

Stairs are often standout architectural features and the backbone of a space; consequently, NovaBell has designed ceramic elements that can be modelled with extreme precision and rigour. **120 cm-wide steps are perfected in every detail and offer incomparable advantages: they complete the flooring, facilitating installation on screed, they are coordinated with the rest of the surfaces and their dimensions correspond to design standards.**

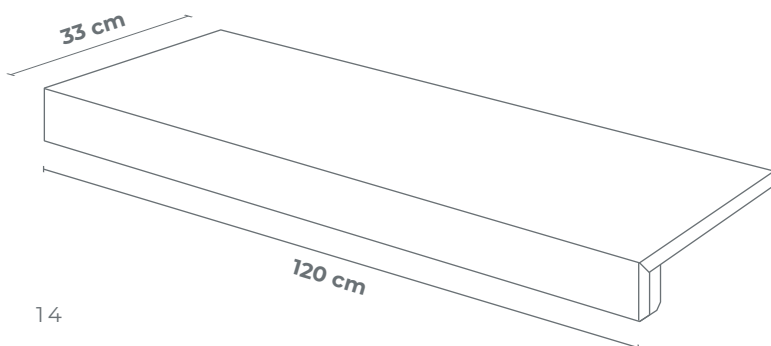





Les escaliers forment bien souvent l'élément clou de l'architecture, mais un point faible au niveau de l'encombrement. Pour cette raison, NovaBell a mis au point des produits céramiques à même de s'adapter avec extrême précision et rigueur. **Les marches de 120 cm de large sont peaufinées dans les moindres détails et comportent des avantages sans pareils : elles complètent les revêtements de sol en simplifiant la pose sur chape, elles sont coordonnées au reste des surfaces et leurs dimensions sont conformes aux standards de la conception.**

Eine Treppe ist oft das markanteste Element einer architektonischen Gestaltung und durchzieht den Raum wie ein Rückgrat. Aus diesem Grund hat NovaBell keramische Elemente entwickelt, die sich dieser Form mit äußerster Präzision anpassen. **Die Stufen mit einer Breite von 120 cm sind bis ins kleinste Detail durchdacht und besitzen außergewöhnliche Vorteile: Sie bilden den Abschluss von Bodenbelägen und erleichtern den Einbau auf dem Estrich, sie sind auf die übrigen Oberflächen abgestimmt und ihre Abmessungen entsprechen den Planungsstandards.**



WALL: Dark Grey Struttura Cesello Rettificato 60x120 - 23<sup>5/8</sup>x47<sup>1/4</sup> / Ivory Struttura Cesello Rettificato 60x120 - 23<sup>5/8</sup>x47<sup>1/4</sup>  
FLOOR: Dark Grey Rettificato 60x120 - 23<sup>5/8</sup>x47<sup>1/4</sup> / Dark Grey 20mm Rettificato 60x120 - 23<sup>5/8</sup>x47<sup>1/4</sup>

- DARK GREY + IVORY -





Fireproof



Non-allergic



Cesello: la superficie materica, decorativa  
e raffinata, progettata per le superfici  
indoor&outdoor.

---

Cesello: the tactile, decorative, refined surface designed  
for indoor and outdoor surfaces.





Cesello : la surface à effet de matière, décorative et raffinée, faite pour l'intérieur et l'extérieur.

Cesello: Edel strukturierte, dekorative Oberflächen für Innen- und Außenbereiche.



FLOOR: Dark Grey Struttura Cesello Rettificato 60x120 - 23<sup>5/8</sup>x47<sup>1/4</sup>



- LIGHT GREY + SLATE -

WALL: Light Grey Struttura Gesello Rettificato 30x120 - 11<sup>13/16</sup>x47<sup>1/4</sup> / Light Grey Rettificato 30x120 - 11<sup>13/16</sup>x47<sup>1/4</sup>  
Slate Rettificato 60x120 - 23<sup>5/8</sup>x47<sup>1/4</sup> - EICHE Timber 20x120 - 7<sup>7/8</sup>x47<sup>1/4</sup>  
FLOOR: Light Grey Rettificato 60x60 - 23<sup>5/8</sup>x23<sup>5/8</sup>





Norgestone si unisce al gres porcellanato effetto legno Eiche arricchendo il **Progetto Integrato** e tutte le raffinate combinazioni materiche NovaBell. La bellezza delle superfici NovaBell non rinuncia alle comodità del miglior gres porcellanato per donare spazi pratici e facili da vivere.

---

Norgestone joins the Eiche wood look porcelain stoneware to extend the potentials of the **Integrated Project** and all NovaBell's refined combinations of materials. The beauty of NovaBell surfaces goes hand in hand with the convenience of the best porcelain stoneware, for practical, lifestyle-friendly spaces.

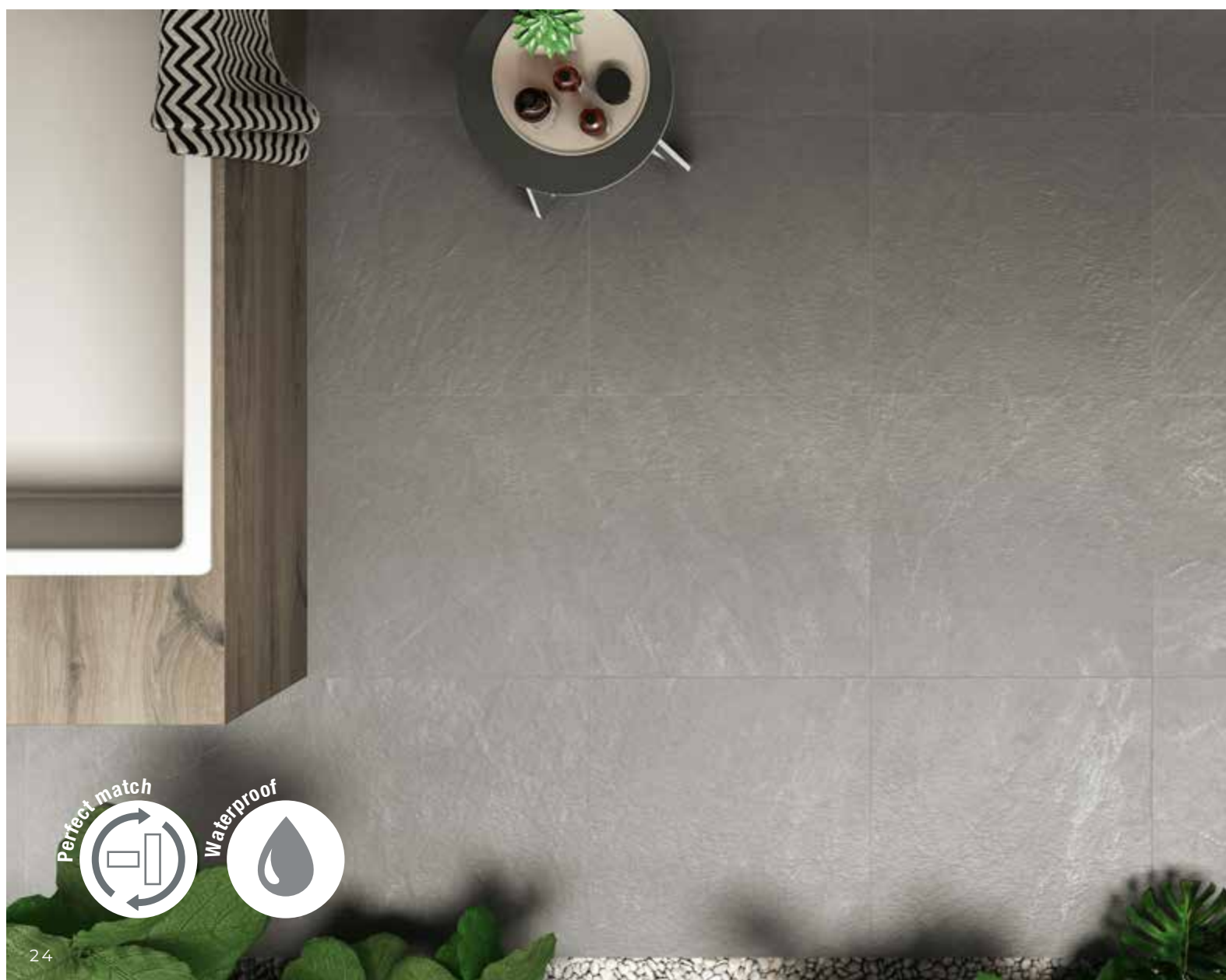



Norgestone s'ajoute au grès cérame effet bois Eiche pour étoffer le **Projet intégré** et tous les élégants accords matières NovaBell. La beauté des surfaces NovaBell ne renonce pas à la fonctionnalité du meilleur grès cérame pour composer des espaces pratiques et simples à vivre.

In Verbindung mit dem Feinsteinzeug in Holzoptik Eiche bereichert Norgestone das **integrierte Projekt** ebenso wie alle weiteren anspruchsvollen, materialbestimmten Kombinationen aus dem Hause NovaBell. Die vollendete Ästhetik der NovaBell-Oberflächen macht keine Abstriche beim Komfort und eignet sich für eine zweckmäßige, pflegeleichte Raumgestaltung.

NORGESTONE  
SNEAKERS



WALL: Ivory Struttura Cesello Rettificato 60x120 - 23<sup>5/8</sup>x47<sup>1/4</sup> / Ivory Rettificato 60x120 - 23<sup>5/8</sup>x47<sup>1/4</sup>  
Slate Struttura Cesello Rettificato 60x120 - 23<sup>5/8</sup>x47<sup>1/4</sup> / Slate Rettificato 60x120 - 23<sup>5/8</sup>x47<sup>1/4</sup>  
FLOOR: Ivory Rettificato 60x120 - 23<sup>5/8</sup>x47<sup>1/4</sup>

- IVORY + SLATE -

DOES  
SNEAK

Total look



Stain-resistant



Easy to clean



Gli abbinamenti cromatici Norgestone progettano la funzionalità degli spazi pubblici. Il gres porcellanato NovaBell possiede tutte le qualità tecniche ed estetiche capaci di soddisfare le rigorose esigenze di progettisti e interior design.

---

Norgestone's colour combinations bring style to the functions of public spaces. NovaBell porcelain stoneware has all the technical and aesthetic qualities required to meet the exacting demands of architects and interior designers.



Les assortiments de couleurs Norgestone forment la fonctionnalité des espaces publics. Le grès cérame NovaBell possède toutes les qualités techniques et esthétiques pour satisfaire les designers et décorateurs d'intérieur les plus exigeants.

Mit den Farbkombinationen von Norgestone lassen sich funktionelle Räume für öffentliche Bereiche gestalten. Die technischen und ästhetischen Eigenschaften des Feinsteinzeugs von NovaBell erfüllen selbst anspruchsvollste Anforderungen von Planern und Interior Designern.

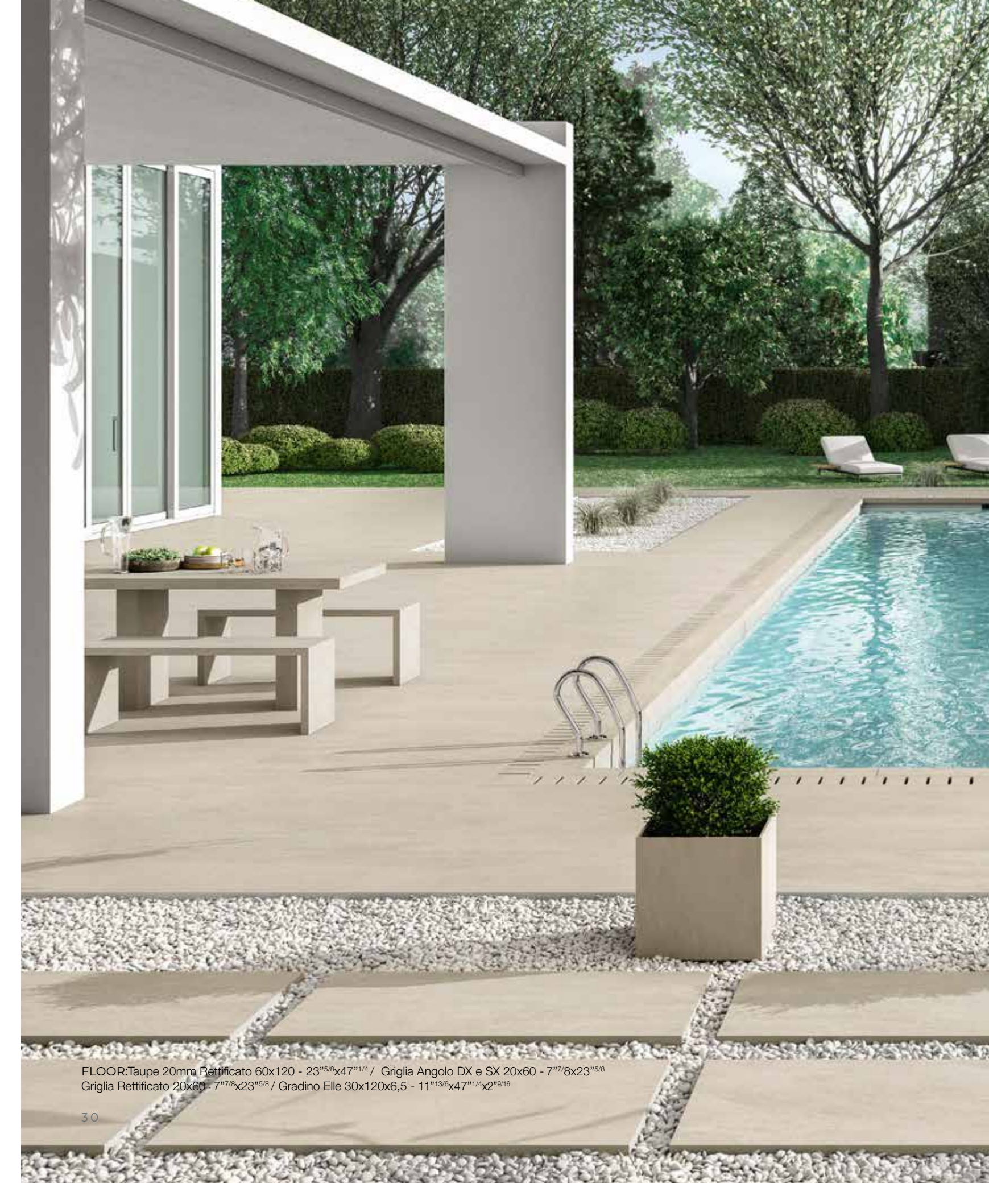

FLOOR: Taupe 20mm Rettificato 60x120 - 23<sup>5/8</sup>x47<sup>1/4</sup> / Griglia Angolo DX e SX 20x60 - 7<sup>7/8</sup>x23<sup>5/8</sup>  
Griglia Rettificato 20x60 - 7<sup>7/8</sup>x23<sup>5/8</sup> / Gradino Elle 30x120x6,5 - 11<sup>13/16</sup>x47<sup>1/4</sup>x2<sup>9/16</sup>





- TAUPE -



**OUT  
WALK**

**20**  
Porcelain  
slabs



Frostproof



Drive-over



Immune to mould and verdigris



- MULTIFUNCTION OUTDOOR SURFACE -

**OutWalk 20** è impermeabile, inassorbente ed è inattaccabile da muffe e verderame. Norgestone è immune agli agenti atmosferici, insieme al vasto assortimento di pezzi speciali permette di risolvere tutti i dettagli di posa.

**OutWalk 20** is waterproof, non-absorbent and immune to attack by moulds and verdigris. Norgestone is completely weather-proof and with its vast assortment of special trims it has solutions for every installation detail.

#### Extérieur multifonctionnel

**OutWalk 20** est imperméable, non-absorbant et résistant aux moisissures et taches de vert-de-gris. Norgestone ne craint pas les intempéries. La grande variété des pièces spéciales permet de parachever la pose dans les moindres détails.

#### Multifunktionelle Oberflächen für Außenbereiche

**OutWalk 20** ist undurchlässig, nicht absorbierend und beständig gegenüber Schimmel und Grünspan. Norgestone ist witterungsbeständig und bietet durch das breite Sortiment an Formteilen Lösungen für alle Verlegeanforderungen.

Antislip



Resistant to salt



- MULTIFUNCTION OUTDOOR SURFACE -

Norgestone est le fruit d'une **profonde connaissance de la matière céramique**.  
Sa fabrication respecte toutes les valeurs du **Made in Italy** : un grès cérame à faible impact  
sur l'environnement, à base de **matières premières d'excellence**.

Das Feinsteinzeug Norgestone basiert auf der **profunden Kenntnis keramischer Werkstoffe**  
und wird nach den Leitprinzipien des „**Made in Italy**“ aus **hervorragenden Rohstoffen**  
umweltschonend produziert.

Norgestone è il risultato di una **profonda conoscenza della materia ceramica**, è prodotta rispettando tutti i valori del **Made in Italy**, assicura un gres porcellanato a basso impatto ambientale ed è realizzata con **materie prime d'eccellenza**.

Norgestone springs from **profound knowledge of ceramics as a material**, is manufactured in accordance with all the genuine values of **Italian design and production**, is a low environmental impact stoneware and is made from **excellent quality raw materials**.





- LICHT GREY -

Norgestone si integra a tutte le collezioni NovaBell per arricchire il progetto integrato, la nuova tendenza dell'interior decoration che prevede la contaminazione tra effetti materici e stilistici.

Norgestone integrates with all NovaBell collections to enhance the integrated project, the new interior decoration trend that involves a fusion of tactile and stylistic effects.



- GREAT VERSATILITY -

WALL: Muretto Mix Light Grey 30x60 - 11<sup>13/16</sup>x23<sup>5/8</sup> / GLOBAL Struttura Bianco Matt 120x45 - 47<sup>1/4</sup>x17<sup>11/16</sup> / Bianco Matt 120x45 - 47<sup>1/4</sup>x17<sup>11/16</sup>  
FLOOR: Light Grey 60x120 - 23<sup>5/8</sup>x47<sup>1/4</sup> / Struttura Cesello Light Grey 60x120 - 23<sup>5/8</sup>x47<sup>1/4</sup>

Norgestone s'assortit à toutes les collections NovaBell pour étayer le projet intégré, tout comme le veut la nouvelle tendance en déco intérieure qui privilégie les fusions entre effets de matières et styles.

Norgestone fügt sich in alle NovaBell Kollektionen ein und bereichert das integrierte Projekt, das unterschiedliche Materialoptiken zu neuartigen Kompositionen zusammenführt und einen neuen Trend im Interior Design darstellt.

# N TAUPE

Rettificato. Rectified. Rectifié. Geschliffen.



cm. 60x120  
inch. 23<sup>5</sup>/<sub>8</sub>x47<sup>1</sup>/<sub>4</sub>

cm. 30x120  
inch. 11<sup>13</sup>/<sub>16</sub>x47<sup>1</sup>/<sub>4</sub>

cm. 60x60  
inch. 23<sup>5</sup>/<sub>8</sub>x23<sup>5</sup>/<sub>8</sub>

cm. 30x60  
inch. 11<sup>13</sup>/<sub>16</sub>x23<sup>5</sup>/<sub>8</sub>



cm. 80x80  
inch. 31<sup>1</sup>/<sub>2</sub>x31<sup>1</sup>/<sub>2</sub>



80x80 - 31<sup>1</sup>/<sub>2</sub>x31<sup>1</sup>/<sub>2</sub>  
**NST 48RT** Taupe Rettificato

02  
1075



60x60 - 23<sup>5</sup>/<sub>8</sub>x23<sup>5</sup>/<sub>8</sub>  
**NST 40RT** Taupe Rettificato

03  
1065



60x120 - 23<sup>5</sup>/<sub>8</sub>x47<sup>1</sup>/<sub>4</sub>  
**NST 42RT** Taupe Rettificato

02  
1075



60x120 - 23<sup>5</sup>/<sub>8</sub>x47<sup>1</sup>/<sub>4</sub>  
**NST 41RT** Struttura Cesello Taupe Rettificato

02  
1085



30x120 - 11<sup>13</sup>/<sub>16</sub>x47<sup>1</sup>/<sub>4</sub>  
**NST 43RT** Taupe Rettificato

03  
1080



30x120 - 11<sup>13</sup>/<sub>16</sub>x47<sup>1</sup>/<sub>4</sub>  
**NST 411R** Struttura Cesello Taupe Rettificato

03  
1085



30x60 - 11<sup>13</sup>/<sub>16</sub>x23<sup>5</sup>/<sub>8</sub>  
**NST 46RT** Taupe Rettificato

07  
1035

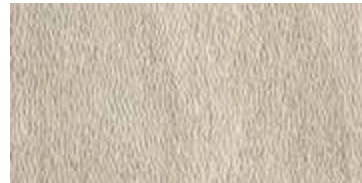

30x60 - 11<sup>13</sup>/<sub>16</sub>x23<sup>5</sup>/<sub>8</sub>  
**NST 461R** Struttura Cesello  
Taupe Rettificato

07  
1045



30x30 - 11<sup>13</sup>/<sub>16</sub>x11<sup>13</sup>/<sub>16</sub>  
**NST 445N** Mos. 5x5  
3 8 Taupe



10  
3115



30x60 - 11<sup>13</sup>/<sub>16</sub>x23<sup>5</sup>/<sub>8</sub>  
**NST 447N** Muretto Taupe

04  
3130

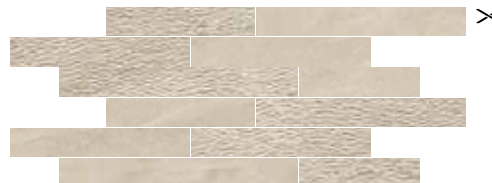

30x60 - 11<sup>13</sup>/<sub>16</sub>x23<sup>5</sup>/<sub>8</sub>  
**NST 446N** Muretto Mix Taupe

04  
3130

	01   670
Gradino Rett. 33x120x4	
NST G41K	
	01   676
Angolo DX Rett. 33x120x4	
NST G42K	
	01   676
Angolo SX Rett. 33x120x4	
NST G45K	
	15   230
Battiscopa 7x60	
NST B40K	



60x120  
inch. 23<sup>5</sup>/<sub>8</sub>x47<sup>1</sup>/<sub>4</sub>  
20 mm



60x120 - 23<sup>5</sup>/<sub>8</sub>x47<sup>1</sup>/<sub>4</sub>  
NST 49RT Taupe 20mm Rettificato **01**  
**1125**



**PEZZI SPECIALI ON DEMAND 20MM\*** Special coordinated pieces. Zusammenstellbare Formteile. Pièces spéciales coordonnées.

02   656	01   665	02   627	02   650	02   650	02   590	02   590	02   590
NST G43K	NST G42K	NST W41K	NST W42K	NST W44K	NST W45K	NST W46K	NST W47K

\* **6** SETTIMANE DI CONSEGNA. / DELIVERY WEEKS. / SEMAINES DE LIVRAISON. / WOCHEN LIEFERZEIT.

OUT WALK	Bending Strength EN 13396	Water Absorption	DIN 51130	DIN 51097	BS 7976 Pendulum Tester Average Values	MOHS	Modulus of Rupture	Breaking Strength (for square slabs)	Compressive Strength
<b>TECHNICAL DATA 20 MM</b>	≥ U11 * for square slabs	≤ 0,03%	R11	A+B+C	wet ≥ 50 dry ≥ 55	≥ 8	≥ 50 N/mm <sup>2</sup>	≥ 12.000 N	≥ 200 N/mm <sup>2</sup>
Resistance to Staining	Resistance to household chemicals and swimming pool salts	Frost Resistance	Thermal Shock	Color Resistance UV Light		Reaction to Fire	≥ 500 kg/cm <sup>2</sup>	≥ 1.200 kg	≥ 2.000 kg/cm <sup>2</sup>
5	A	Complies	Resistant	Resistant		A1FL	≥ 7,500 psi	≥ 2,700 lbs	≥ 29,000 psi

# N LIGHT GREY

Rettificato. Rectified. Rectifié. Geschliffen.



cm. 60x120  
inch. 23<sup>5</sup>/<sub>8</sub>x47<sup>1</sup>/<sub>4</sub>

cm. 30x120  
inch. 11<sup>13</sup>/<sub>16</sub>x47<sup>1</sup>/<sub>4</sub>

cm. 60x60  
inch. 23<sup>5</sup>/<sub>8</sub>x23<sup>5</sup>/<sub>8</sub>

cm. 30x60  
inch. 11<sup>13</sup>/<sub>16</sub>x23<sup>5</sup>/<sub>8</sub>



cm. 80x80  
inch. 31<sup>1</sup>/<sub>2</sub>x31<sup>1</sup>/<sub>2</sub>



80x80 - 31<sup>1</sup>/<sub>2</sub>x31<sup>1</sup>/<sub>2</sub>  
**NST 18RT** Light Grey Rettificato

02  
1075



60x60 - 23<sup>5</sup>/<sub>8</sub>x23<sup>5</sup>/<sub>8</sub>  
**NST 10RT** Light Grey Rettificato

03  
1065



60x120 - 23<sup>5</sup>/<sub>8</sub>x47<sup>1</sup>/<sub>4</sub>  
**NST 12RT** Light Grey Rettificato

02  
1075



60x120 - 23<sup>5</sup>/<sub>8</sub>x47<sup>1</sup>/<sub>4</sub>  
**NST 11RT** Struttura Cesello Light Grey Rettificato

02  
1085



30x120 - 11<sup>13</sup>/<sub>16</sub>x47<sup>1</sup>/<sub>4</sub>  
**NST 13RT** Light Grey Rettificato

03  
1080

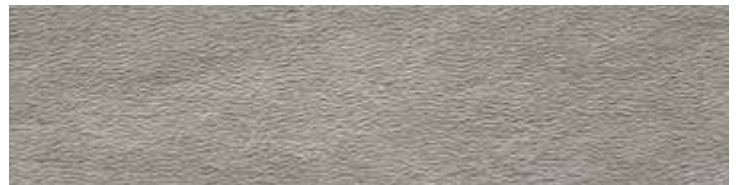

30x120 - 11<sup>13</sup>/<sub>16</sub>x47<sup>1</sup>/<sub>4</sub>  
**NST 111R** Struttura Cesello Light Grey Rettificato

03  
1085



30x60 - 11<sup>13</sup>/<sub>16</sub>x23<sup>5</sup>/<sub>8</sub>  
**NST 16RT** Light Grey Rettificato

07  
1035



30x60 - 11<sup>13</sup>/<sub>16</sub>x23<sup>5</sup>/<sub>8</sub>  
**NST 161R** Struttura Cesello  
Light Grey Rettificato

07  
1045

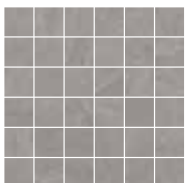

30x30 - 11<sup>13</sup>/<sub>16</sub>x11<sup>13</sup>/<sub>16</sub>  
**NST 115N** Mos. 5x5  
40 Light Grey



10  
3115

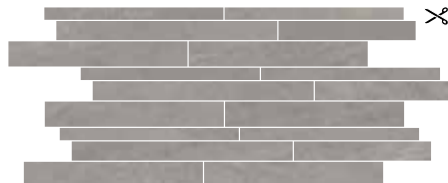

30x60 - 11<sup>13</sup>/<sub>16</sub>x23<sup>5</sup>/<sub>8</sub>  
**NST 117N** Muretto Light Grey

04  
3130



30x60 - 11<sup>13</sup>/<sub>16</sub>x23<sup>5</sup>/<sub>8</sub>  
**NST 116N** Muretto Mix Light Grey

04  
3130

01   670
Gradino Rett. 33x120x4 NST G11K
01   676
Angolo DX Rett. 33x120x4 NST G12K
01   676
Angolo SX Rett. 33x120x4 NST G15K
15   230
Battiscopa 7x60 NST B10K



**cm. 60x180**  
inch. 23<sup>5</sup>/<sub>8</sub>x70<sup>7</sup>/<sub>8</sub>

**cm. 60x120**  
inch. 23<sup>5</sup>/<sub>8</sub>x47<sup>1</sup>/<sub>4</sub>

**cm. 60x90**  
inch. 23<sup>5</sup>/<sub>8</sub>x35<sup>7</sup>/<sub>16</sub>



60x180 - 23<sup>5</sup>/<sub>8</sub>x70<sup>7</sup>/<sub>8</sub>  
**NST 118R** Light Grey 20mm Rettificato **1130**



60x120 - 23<sup>5</sup>/<sub>8</sub>x47<sup>1</sup>/<sub>4</sub>  
**NST 19RT** Light Grey 20mm Rettificato **1125**

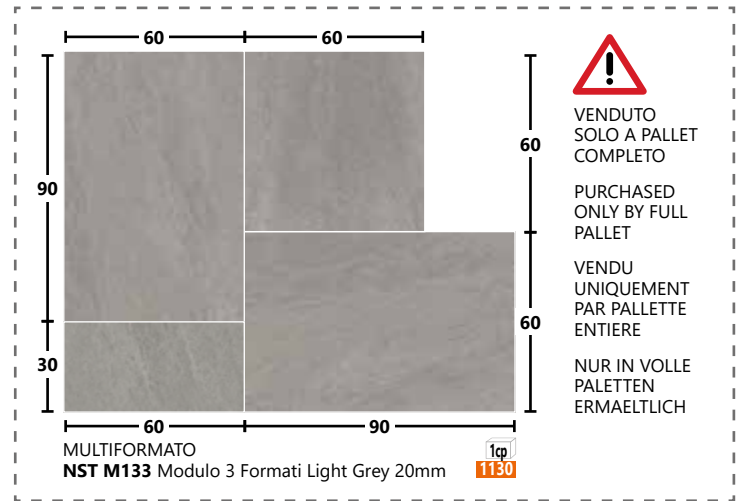

60x90 - 23<sup>5</sup>/<sub>8</sub>x35<sup>7</sup>/<sub>16</sub>  
**NST 169R** Light Grey 20mm Rettificato **1120**

**PEZZI SPECIALI ON DEMAND 20MM\*** Special coordinated pieces. Zusammenstellbare Formteile. Pièces spéciales coordonnées.

<b>02</b> <b>656</b>	<b>01</b> <b>665</b>	<b>01</b> <b>683</b>	<b>01</b> <b>684</b>	<b>01</b> <b>685</b>	<b>02</b> <b>627</b>	<b>02</b> <b>650</b>	<b>02</b> <b>650</b>	<b>02</b> <b>590</b>	<b>02</b> <b>590</b>	<b>02</b> <b>590</b>
<b>NST G13K</b>	<b>NST G12K</b>	<b>NST G183</b>	<b>NST G184</b>	<b>NST G185</b>	<b>NST W11K</b>	<b>NST W12K</b>	<b>NST W14K</b>	<b>NST W15K</b>	<b>NST W16K</b>	<b>NST W17K</b>

\* **6** SETTIMANE DI CONSEGNA. / DELIVERY WEEKS. / SEMAINES DE LIVRAISON. / WOCHEN LIEFERZEIT.

<b>OUT WALK</b> <b>TECHNICAL DATA</b> <b>20 MM</b>	Bending Strength EN 13396 ≥ U11 * for square slabs	Water Absorption ≤ 0,03%	DIN 51130 R11	DIN 51097 A+B+C	BS 7976 Pendulum Tester Average Values wet ≥ 50 dry ≥ 55	MOHS ≥ 8	Modulus of Rupture ≥ 50 N/mm <sup>2</sup>	Breaking Strength (for square slabs) ≥ 12.000 N	Compressive Strength ≥ 200 N/mm <sup>2</sup>	
	Resistance to Staining 5	Resistance to household chemicals and swimming pool salts A	Frost Resistance Complies	Thermal Shock Resistant		Color Resistance UV Light Resistant	Reaction to Fire A1FL	≥ 500 kg/cm <sup>2</sup> ≥ 7,500 psi	≥ 1.200 kg ≥ 2,700 lbs	≥ 2.000 kg/cm <sup>2</sup> ≥ 29,000 psi

# N DARK GREY

Rettificato. Rectified. Rectifié. Geschliffen.



cm. 60x120  
inch. 23<sup>5</sup>/<sub>8</sub>x47<sup>1</sup>/<sub>4</sub>

cm. 30x120  
inch. 11<sup>13</sup>/<sub>16</sub>x47<sup>1</sup>/<sub>4</sub>

cm. 60x60  
inch. 23<sup>5</sup>/<sub>8</sub>x23<sup>5</sup>/<sub>8</sub>

cm. 30x60  
inch. 11<sup>13</sup>/<sub>16</sub>x23<sup>5</sup>/<sub>8</sub>



cm. 80x80  
inch. 31<sup>1</sup>/<sub>2</sub>x31<sup>1</sup>/<sub>2</sub>



80x80 - 31<sup>1</sup>/<sub>2</sub>x31<sup>1</sup>/<sub>2</sub>  
**NST 28RT** Dark Grey Rettificato

02  
1075



60x60 - 23<sup>5</sup>/<sub>8</sub>x23<sup>5</sup>/<sub>8</sub>  
**NST 20RT** Dark Grey Rettificato

03  
1065



60x120 - 23<sup>5</sup>/<sub>8</sub>x47<sup>1</sup>/<sub>4</sub>  
**NST 22RT** Dark Grey Rettificato

02  
1075

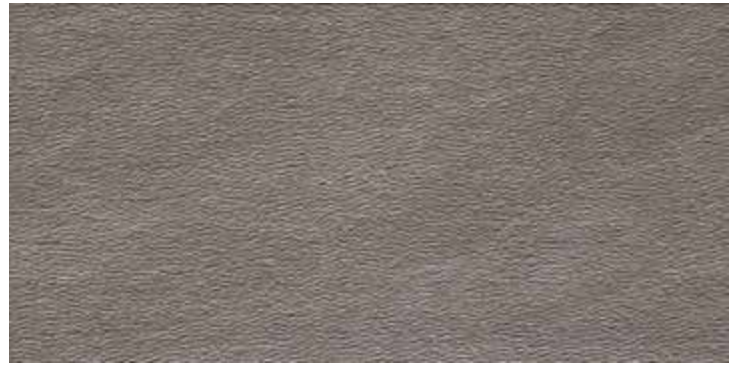

60x120 - 23<sup>5</sup>/<sub>8</sub>x47<sup>1</sup>/<sub>4</sub>  
**NST 21RT** Struttura Cesello Dark Grey Rettificato

02  
1085



30x120 - 11<sup>13</sup>/<sub>16</sub>x47<sup>1</sup>/<sub>4</sub>  
**NST 23RT** Dark Grey Rettificato

03  
1080

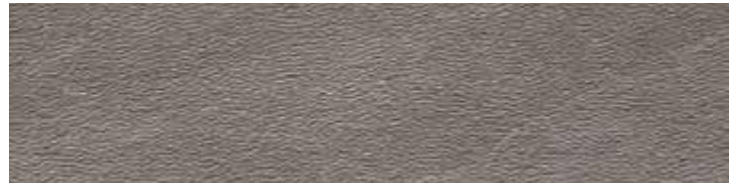

30x120 - 11<sup>13</sup>/<sub>16</sub>x47<sup>1</sup>/<sub>4</sub>  
**NST 211R** Struttura Cesello Dark Grey Rettificato

03  
1085



30x60 - 11<sup>13</sup>/<sub>16</sub>x23<sup>5</sup>/<sub>8</sub>  
**NST 26RT** Dark Grey Rettificato

07  
1035



30x60 - 11<sup>13</sup>/<sub>16</sub>x23<sup>5</sup>/<sub>8</sub>  
**NST 261R** Struttura Cesello  
Dark Grey Rettificato

07  
1045

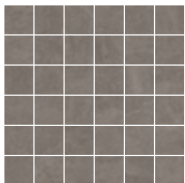

30x30 - 11<sup>13</sup>/<sub>16</sub>x11<sup>13</sup>/<sub>16</sub>  
**NST 225N** Mos. 5x5  
42 Dark Grey



10  
3115

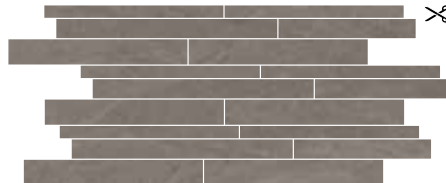

30x60 - 11<sup>13</sup>/<sub>16</sub>x23<sup>5</sup>/<sub>8</sub>  
**NST 227N** Muretto Dark Grey

04  
3130

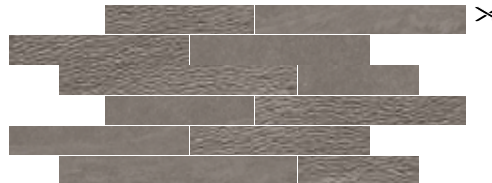

30x60 - 11<sup>13</sup>/<sub>16</sub>x23<sup>5</sup>/<sub>8</sub>  
**NST 226N** Muretto Mix Dark Grey

04  
3130

01   670
Gradino Rett. 33x120x4 NST G21K
01   676
Angolo DX Rett. 33x120x4 NST G22K
01   676
Angolo SX Rett. 33x120x4 NST G25K
15   230
Battiscopa 7x60 NST B20K



**cm. 60x180**  
inch. 23<sup>5</sup>/<sub>8</sub>x70<sup>7</sup>/<sub>8</sub>

**cm. 60x120**  
inch. 23<sup>5</sup>/<sub>8</sub>x47<sup>1</sup>/<sub>4</sub>

**cm. 60x90**  
inch. 23<sup>5</sup>/<sub>8</sub>x35<sup>7</sup>/<sub>16</sub>



60x180 - 23<sup>5</sup>/<sub>8</sub>x70<sup>7</sup>/<sub>8</sub>  
**NST 218R** Dark Grey 20mm Rettificato **01 1130**



60x120 - 23<sup>5</sup>/<sub>8</sub>x47<sup>1</sup>/<sub>4</sub>  
**NST 29RT** Dark Grey 20mm Rettificato **01 1125**



60x90 - 23<sup>5</sup>/<sub>8</sub>x35<sup>7</sup>/<sub>16</sub>  
**NST 269R** Dark Grey 20mm Rettificato **01 1120**

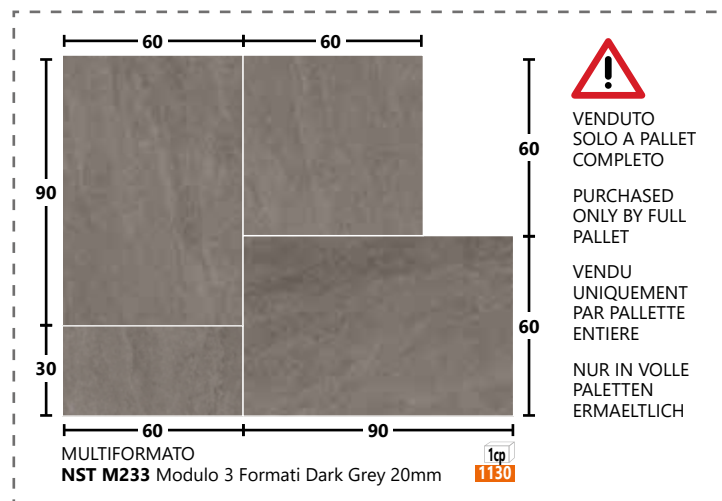

**PEZZI SPECIALI ON DEMAND 20MM\*** Special coordinated pieces. Zusammenstellbare Formteile. Pièces spéciales coordonnées.

<b>02 656</b>	<b>01 665</b>	<b>01 683</b>	<b>01 684</b>	<b>01 685</b>	<b>02 627</b>	<b>02 650</b>	<b>02 650</b>	<b>02 590</b>	<b>02 590</b>	<b>02 590</b>
<b>NST G23K</b>	<b>NST G22K</b>	<b>NST G283</b>	<b>NST G284</b>	<b>NST G285</b>	<b>NST W21K</b>	<b>NST W22K</b>	<b>NST W24K</b>	<b>NST W25K</b>	<b>NST W26K</b>	<b>NST W27K</b>

\* **6** SETTIMANE DI CONSEGNA. / DELIVERY WEEKS. / SEMAINES DE LIVRAISON. / WOCHEN LIEFERZEIT.

OUT WALK	Bending Strength EN 13396	Water Absorption	DIN 51130	DIN 51097	BS 7976 Pendulum Tester Average Values	MOHS	Modulus of Rupture	Breaking Strength (for square slabs)	Compressive Strength
<b>TECHNICAL DATA 20 MM</b>	≥ U11 * for square slabs	≤ 0,03%	R11	A+B+C	wet ≥ 50 dry ≥ 55	≥ 8	≥ 50 N/mm <sup>2</sup>	≥ 12.000 N	≥ 200 N/mm <sup>2</sup>
Resistance to Staining	Resistance to household chemicals and swimming pool salts	Frost Resistance	Thermal Shock	Color Resistance UV Light		Reaction to Fire	≥ 500 kg/cm <sup>2</sup>	≥ 1.200 kg	≥ 2.000 kg/cm <sup>2</sup>
5	A	Complies	Resistant	Resistant		A1FL	≥ 7,500 psi	≥ 2,700 lbs	≥ 29,000 psi

# N SLATE

Rettificato. Rectified. Rectifié. Geschliffen.



cm. 60x120  
inch. 23<sup>5</sup>/<sub>8</sub>x47<sup>1</sup>/<sub>4</sub>

cm. 30x120  
inch. 11<sup>13</sup>/<sub>16</sub>x47<sup>1</sup>/<sub>4</sub>

cm. 60x60  
inch. 23<sup>5</sup>/<sub>8</sub>x23<sup>5</sup>/<sub>8</sub>

cm. 30x60  
inch. 11<sup>13</sup>/<sub>16</sub>x23<sup>5</sup>/<sub>8</sub>



cm. 60x120  
inch. 23<sup>5</sup>/<sub>8</sub>x47<sup>1</sup>/<sub>4</sub>



60x120 - 23<sup>5</sup>/<sub>8</sub>x47<sup>1</sup>/<sub>4</sub>  
**NST 92RT** Slate Rettificato

02  
1075



60x120 - 23<sup>5</sup>/<sub>8</sub>x47<sup>1</sup>/<sub>4</sub>  
**NST 91RT** Struttura Cesello Slate Rettificato

02  
1085

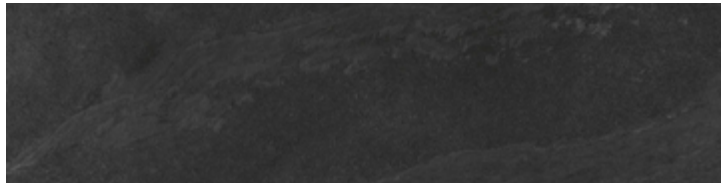

30x120 - 11<sup>13</sup>/<sub>16</sub>x47<sup>1</sup>/<sub>4</sub>  
**NST 93RT** Slate Rettificato

03  
1080



30x120 - 11<sup>13</sup>/<sub>16</sub>x47<sup>1</sup>/<sub>4</sub>  
**NST 911R** Struttura Cesello Slate Rettificato

03  
1085

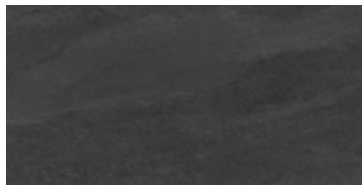

30x60 - 11<sup>13</sup>/<sub>16</sub>x23<sup>5</sup>/<sub>8</sub>  
**NST 96RT** Slate Rettificato

07  
1035

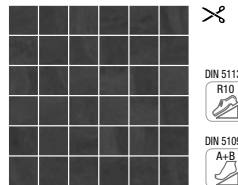

30x30 - 11<sup>13</sup>/<sub>16</sub>x11<sup>13</sup>/<sub>16</sub>  
**NST 995N** Mos. 5x5  
Slate



10  
8115



30x60 - 11<sup>13</sup>/<sub>16</sub>x23<sup>5</sup>/<sub>8</sub>  
**NST 961R** Struttura Cesello  
Slate Rettificato

07  
1045



60x60 - 23<sup>5</sup>/<sub>8</sub>x23<sup>5</sup>/<sub>8</sub>  
**NST 90RT** Slate Rettificato

03  
1065

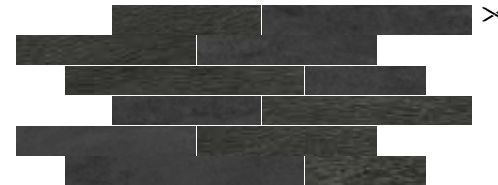

30x60 - 11<sup>13</sup>/<sub>16</sub>x23<sup>5</sup>/<sub>8</sub>  
**NST 996N** Muretto Mix Slate

04  
3130

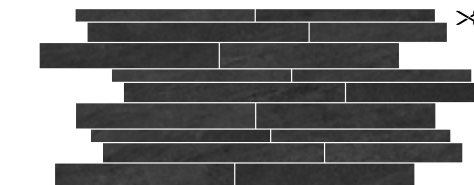

30x60 - 11<sup>13</sup>/<sub>16</sub>x23<sup>5</sup>/<sub>8</sub>  
**NST 997N** Muretto Slate

04  
3130

	01   670
Gradino Rett. 33x120x4	
NST G91K	
	01   676
Angolo DX Rett. 33x120x4	
NST G92K	
	01   676
Angolo SX Rett. 33x120x4	
NST G95K	
	15   230
Battiscopa 7x60	
NST B90K	

**PEZZI SPECIALI ON DEMAND 20MM\*** Special coordinated pieces. Zusammenstellbare Formteile. Pièces spéciales coordonnées.

Toro Gradino Rettificato 30x120	Gradino Elle Rettificato 30x120x4	Bordo Rett. Antiderapant 30x60	Bordo Angolo SX Rett. 30x60	Bordo Angolo DX Rett. 30x60	Griglia Rettificata 20x60	Griglia Angolo SX Rett. 20x60	Griglia Angolo DX Rett. 20x60
02   656	01   665	02   627	02   650	02   650	02   590	02   590	02   590
NST G93K	NST G92K	NST W91K	NST W92K	NST W94K	NST W95K	NST W96K	NST W97K



60x120 - 23<sup>5</sup>/<sub>8</sub>x47<sup>1</sup>/<sub>4</sub>  
**NST 99RT** Slate 20mm Rettificato

01  
1125

# N IVORY

Rettificato. Rectified. Rectifié. Geschliffen.



cm. 60x120  
inch. 23<sup>5</sup>/<sub>8</sub>x47<sup>1</sup>/<sub>4</sub>

cm. 30x120  
inch. 11<sup>13</sup>/<sub>16</sub>x47<sup>1</sup>/<sub>4</sub>

cm. 60x60  
inch. 23<sup>5</sup>/<sub>8</sub>x23<sup>5</sup>/<sub>8</sub>

cm. 30x60  
inch. 11<sup>13</sup>/<sub>16</sub>x23<sup>5</sup>/<sub>8</sub>



60x120 - 23<sup>5</sup>/<sub>8</sub>x47<sup>1</sup>/<sub>4</sub>  
**NST 82RT** Ivory Rettificato

02  
1075



30x120 - 11<sup>13</sup>/<sub>16</sub>x47<sup>1</sup>/<sub>4</sub>  
**NST 83RT** Ivory Rettificato

03  
1080



30x60 - 11<sup>13</sup>/<sub>16</sub>x23<sup>5</sup>/<sub>8</sub>  
**NST 86RT** Ivory Rettificato

07  
1035



60x60 - 23<sup>5</sup>/<sub>8</sub>x23<sup>5</sup>/<sub>8</sub>  
**NST 80RT** Ivory Rettificato

03  
1065



60x120 - 23<sup>5</sup>/<sub>8</sub>x47<sup>1</sup>/<sub>4</sub>  
**NST 81RT** Struttura Cesello Ivory Rettificato

02  
1085



30x120 - 11<sup>13</sup>/<sub>16</sub>x47<sup>1</sup>/<sub>4</sub>  
**NST 811R** Struttura Cesello Ivory Rettificato

03  
1085



30x60 - 11<sup>13</sup>/<sub>16</sub>x23<sup>5</sup>/<sub>8</sub>  
**NST 861R** Struttura Cesello Ivory Rettificato

07  
1045

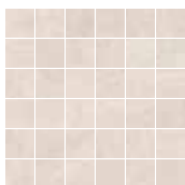

30x30 - 11<sup>13</sup>/<sub>16</sub>x11<sup>13</sup>/<sub>16</sub>  
**NST 885N** Mos. 5x5  
Ivory

10  
3115

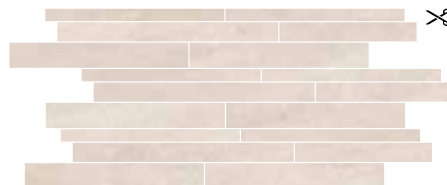

30x60 - 11<sup>13</sup>/<sub>16</sub>x23<sup>5</sup>/<sub>8</sub>  
**NST 887N** Muretto Ivory

04  
3130

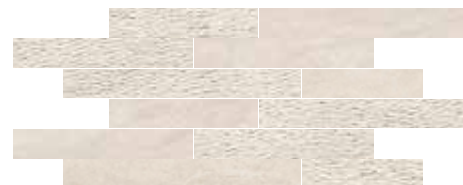

30x60 - 11<sup>13</sup>/<sub>16</sub>x23<sup>5</sup>/<sub>8</sub>  
**NST 886N** Muretto Mix Ivory

04  
3130

	01   670
Gradino Rett. 33x120x4	
NST G81K	
	01   676
Angolo DX Rett. 33x120x4	
NST G82K	
	01   676
Angolo SX Rett. 33x120x4	
NST G85K	
	15   230
Battiscopa 7x60	
NST B80K	

The International reference standards: ANSI - ASTM

# NATURALE

Characteristics and Test methods 	Requirements ANSI A 137.1	Our general values
Determination of water absorption - (ASTM C 373)	Average value $E_b \leq 0,5 \%$	Average value $\leq 0,06 \%$
<b>Classification</b>	<b>Definition § 3.0</b>	<b>Porcelain tiles</b>
		<b>Physical properties</b>
Breaking strength - (ASTM C 648)	Average $\geq 250$ lbf (1.11 kN) Individual $\geq 225$ lbf (1.00 kN)	Complies
Visible abrasion - (ASTM C 1027)	As reported	Class 0 - 5
Raccomanded use	Novabell criterion (see Annex N - ISO 13006 / EN 14411)	Class 4
Thermal shock resistance (ASTM C 428)	Pass	Complies
Crazing resistance (ASTM C 424)	Pass	Complies
Resistance to freeze/thaw cycling (ASTM C 1026)	As reported	Resistant
<b>DCOF Resistance</b> (ANSI A 137.1 Section 9.6)	$\geq 0.42^{(1)}$	DCOF $\geq 0.42$
Bond strength (ASTM C 482)	$\geq 50$ psi (0.34 MPa)	$> 1$ MPa
Color Uniformity (ASTM C 609 and ANSI A 137.1 Section 9.3) <sup>(2)</sup>	V0 - 3 Judds	See the specific section
		<b>Chemical properties</b>
Chemical resistance (ASTM C 650)	As reported	Resistant
Stain resistance (ASTM C 1378)	As reported	Resistant
		<b>Dimensions - Calibrated tiles</b>
Dimensions - (ASTM C 499) - (ASTM C 485) - (ASTM C 502)	See ANSI A 137.1 - Tab.10	Complies
		<b>Dimensions - Rectified tiles</b>
Dimensions - (ASTM C 499) - (ASTM C 485) - (ASTM C 502)	See ANSI A 137.1 - Tab.10	Complies
Scrath hardenss of surface according to Mohs'	ex BS 6431-13 / ex EN 101	$\geq 5$

(1) For level interior spaces expected to be walked upon when wet - (2) For V0 tiles only



**NORGESTONE  
NATURALE**

 Utilizzare il **QR CODE** per scaricare le schede tecniche

 Use the **QR CODE** to download data sheets



**NORGESTONE  
20MM**

 Veuillez utiliser le **QR CODE** pour télécharger les fiches techniques

 **QR CODE** benutzen um die technische datenblätter runter zu laden



The international reference standards: ISO - EN

# NATURALE

Characteristics and Test methods 	Requirements EN 14411 <sup>(1)</sup> – G / ISO 13006 <sup>(2)</sup> - G	Our general values
Determination of water absorption - (ISO 10545-3)	Average value $E_p \leq 0,5\%$ / Individual maximum 0,6%	$\leq 0,06\%$ Average value and individual maximum
<b>Classification</b>	<b>Definition § 3.2 and § 3.7</b>	<b>BI<sub>3</sub> – Porcelain tiles</b>
		<b>Physical properties</b>
Modulus of rupture - (ISO 10545-4)	Average $\geq 35$ N/mm <sup>2</sup>	$\geq 35$ N/mm <sup>2</sup>
Breaking strength - (ISO 10545-4)	Average $\geq 1300$ N for thickness $\geq 7,5$ mm Average $\geq 700$ N for thickness $< 7,5$ mm	Complies
Resistance to surface abrasion - (ISO 10545-7)	Abrasion class and cycles passed	Class 0 - 5
Resistance to deep abrasion - (ISO 10545 - 6)	Max volume abraded $< 175$ / mm <sup>3</sup>	$< 175$ / mm <sup>3</sup>
Raccomanded use	Novabell criterion (see Annex N - ISO 13006 / EN 14411)	Class 4
Coefficient of linear thermal expansion (ISO 10545-8)	Declared value <sup>(1)</sup> / Test method available <sup>(2)</sup>	$< 7,1 \times 10^{-6} \text{ } ^\circ\text{C}^{-1}$
Thermal shock resistance (ISO 10545-9)	Pass according to EN ISO 10545-1 <sup>(1)</sup> / Test method available <sup>(2)</sup>	Complies
Crazing resistance (ISO 10545-11)	Pass according to EN ISO 10545-1 <sup>(1)</sup> / Required <sup>(2)</sup>	Complies
Frost resistance (ISO 10545-12)	Pass according to EN ISO 10545-1 <sup>(1)</sup> / Required <sup>(2)</sup>	Complies
Moisture expansion (ISO 10545-10)	Declared value <sup>(1)</sup> / Test method available <sup>(2)</sup>	$\leq 0,2$ mm/m
Small colour differences (ISO 10545-16)	$\Delta E_{cmc} < 0,75$ <sup>(1)</sup>	If agreed
Impact resistance - (ISO 10545-5)	Declared value <sup>(1)</sup> / Test method available <sup>(2)</sup>	COR $> 0,75$
Reaction to fire	Class A1 or A1 <sub>FL</sub> <sup>(1)</sup>	A1 <sub>FL</sub> Classified Without Testing (CWT) – 96/603
		<b>Chemical properties</b>
Chemical resistance -(GL) (ISO 10545-13)		
Resistance to low and high concentrations of acids and alkalis	Declared value <sup>(1)</sup> / Manufacturer is to state classification <sup>(2)</sup>	Resistant (see "Maintenance and care" section)
Resistance to household chemicals and swimming pool salts	Minimum class B	G A
Resistance to staining (ISO 10545-14)	Minimum class 3	5 (see "Maintenance and care" section)
Release of dangerous substances (ISO 10545-15)	Declared value <sup>(1)</sup> / Test method available <sup>(2)</sup>	Pb $< 0,1$ / Cd $< 0,01$ mg/dm <sup>2</sup>
		<b>Dimensions and surface quality</b>
Dimensions - (ISO 10545-2)	See ANNEX G	Complies
Surface quality - (ISO 10545-2 § 7)	<b>A minimum of 95% of the tiles shall be free from visible defects that would impair the appearance of a major area of tiles</b>	Complies

(1) Requirements according to EN 14411

(2) Requirements according to ISO 13006

Test methods	Requirements and references	Our general values
Determination of anti-slip properties – Workrooms and fields of activities with raised slip danger, walking method-Ramp test (DIN 51130)-Germany	BGR / ASR From R9 to R13	R 10
Determination of anti – slip properties. Wet-loaded barefoot areas – Walking method – Ramp test (DIN 51097) - Germany	GUV-I 8527 A – B – C	A + B
Dynamic Coefficient Friction wet and dry condition (BCR-ex BCRA) Italy	DM n. 236 / 1989 $\mu > 0,40$	$\mu > 0,40$
Scrath hardenss of surface according to Mohs'	ex BS 6431-13 / ex EN 101	$\geq 5$

 La tabella in italiano con i dati tecnici è scaricabile su [www.novabell.it](http://www.novabell.it)

 Si vous le souhaitez, téléchargez le tableau contenant les données techniques en français en allant sur [www.novabell.it](http://www.novabell.it)

 The English language technical specification for each collection can be downloaded from [www.novabell.it](http://www.novabell.it)

 Die Tabelle in deutscher Sprache kann auf [www.novabell.it](http://www.novabell.it) heruntergeladen werden.

# MERCHANDISING



PG NST FT



Struttura Cesello 60x120



PG NST 60x120



PG NST 80



PG NST 120



PG NST 60









PG NST 60



SCANST6



SCA-NST

	SCATOLA / BOX			PALLET			≡ ▲
	pz	m2	kg	box	m2	kg	
60x120	2	1,440	30,7 	32	46,080	983	10
30x120	3	1,080	23,8	24	25,920	571	10
60x60	3	1,080	22,5	40	43,200	900	10
30x60	7	1,260	25,9 	40	50,400	1036	10
80x80	2	1,280	27,9 	40	51,200	1116	10,5
60x180	1	1,080	48,0 	20	21,600	960	20
60x120	1	0,720	32,2 	32	23,040	1030	20
60x90	1	0,540	23,9	44	26,760	1052	20
Modulo 3 formati	1 cp.	1,620	71,7 	14 cp.	22,68	1004	20



**IT - I laboratori di ricerca NovaBell hanno creato una nuova generazione di superfici, caratterizzate dalla innovativa tecnologia digitale ad alta definizione.**

**GB - The NovaBell research laboratories have created a new generation of surfaces, featuring innovative high-definition digital technology.**

**D - Die NovaBell Forschungslabors haben eine neue Generation von Oberflächen entwickelt, die durch die innovative hoch auflösende Digitaltechnologie gekennzeichnet sind.**

**F - Les laboratoires de recherche NovaBell ont créé une nouvelle génération de surfaces, qui se caractérisent par une technologie numérique haute définition innovante.**

**ES - Los laboratorios de investigación NovaBell han creado una nueva generación de superficies, caracterizadas por la innovadora tecnología digital de alta definición.**

**RU - В научно-исследовательской лаборатории NOVABELL было разработано новое поколение поверхностей, отличающихся инновационной цифровой технологией высокого разрешения.**

**TECNOLOGIA, INNOVAZIONE  
E RICERCA NOVABELL**

## LEED® CERTIFICATION COMPLIANT

**NORGESTONE E' UN PRODOTTO CON PARTICOLARI CARATTERISTICHE DI ECOSOSTENIBILITA', CHE CONTRIBUISCE ALL'OTTENIMENTO DEI CREDITI PER LA CERTIFICAZIONE LEED (LEADERSHIP IN ENERGY AND ENVIROMENTAL DESIGN).**



NORGESTONE IS A PRODUCT WITH PARTICULAR ENVIRONMENTAL SUSTAINABILITY CHARACTERISTICS, THAT HELPS IN OBTAINING POINTS FOR LEED (LEADERSHIP IN ENERGY AND ENVIRONMENTAL DESIGN) CERTIFICATION.

NORGESTONE IST EIN AUSGESPROCHEN UMWELTFREUNDLICHES PRODUKT, DAS ZUM ERREICHEN DER PUNKTE FÜR DIE ZERTIFIZIERUNG NACH LEED (LEADERSHIP IN ENERGY AND ENVIROMENTAL DESIGN) BEITRÄGT.

LA SERIE NORGESTONE PRESENTE DE CARACTERISTIQUES SPECIFIQUES DE DEVELOPPEMENT DURABLE; ELLE CONTRIBUS A OBTENIR DE CREDITS POUR LA CERTIFICATION LEED (LEADERSHIP IN ENERGY AND ENVIROMENTAL DESIGN).

NORGESTONE ES UN PRODUCTO CON CARACTERÍSTICAS DE SOSTENIBILIDAD MEDIOAMBIENTAL ESPECIALES, QUE FACILITA LA OBTENCIÓN DE PUNTOS PARA LA CERTIFICACIÓN LEED (LEADERSHIP IN ENERGY AND ENVIRONMENTAL DESIGN) LIDERAZGO EN ENERGÍA Y DISEÑO AMBIENTAL.

NORGESTONE - ЭТО ПРОДУКЦИЯ СО СПЕЦИАЛЬНЫМИ ХАРАКТЕРИСТИКАМИ ЭКОЛОГИЧЕСКОЙ ЭФФЕКТИВНОСТИ, ПОЗВОЛЯЮЩАЯ ПОЛУЧАТЬ ЗАЧЕТНЫЕ ОЧКИ ДЛЯ СЕРТИФИКАТА LEED (LEADERSHIP IN ENERGY AND ENVIROMENTAL DESIGN).



CAT-NST



# NovaBell

**NOVABELL SpA CERAMICHE ITALIANE**  
via Molino, 1 - 42014 Roteglia (RE), Italia  
T +39 0536 86 11 11 - F +39 0536 85 12 05  
info@novabell.it - export@novabell.it  
[www.novabell.it](http://www.novabell.it)

