

MADE IN ITALY. MADE TO EXCEL.

# BOOST

PRO



atlas concorde

March 2020





# INDEX

Overview



Spaces

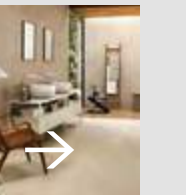
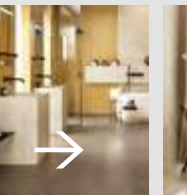
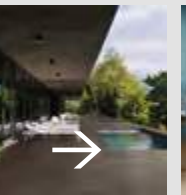
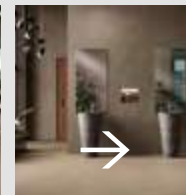
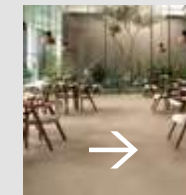

Product Range



Technical Specifications





# WARM "CONCRETE LOOK" FOR A COMFORTABLE URBAN STYLE

The warmth of a lived-in environment, the authenticity of places reborn to a new life, and the simple elegance of industrial recovery are the values evoked by the Boost Pro collection, which adds new warm shades to the cement effect, increasing its expressive potential for interior and exterior design.

Il calore di un ambiente vissuto, l'autenticità di luoghi che nascono a nuova vita, l'eleganza sobria del recupero industriale sono i valori evocati dalla collezione Boost Pro che aggiunge nuove tonalità calde all'effetto cemento, aumentandone le potenzialità espressive per il design d'interni ed esterni.

La chaleur d'un lieu vécu, l'authenticité de lieux qui reprennent vie, la sobre élégance de la récupération industrielle sont les valeurs évoquées par la collection Boost Pro qui ajoute de nouvelles tonalités chaudes à l'effet ciment, en augmentant les potentialités d'expression du design d'intérieur et d'extérieur.

Die Wärme eines von Leben erfüllten Ambiente, die Authentizität von Orten, die zu neuem Leben erweckt werden, die schlichte Eleganz umfunktionierter Industriebauten. All das strahlt die Kollektion Boost Pro aus, die der Zementoptik neue, warme Farbtöne verleiht und ihre Ausdrucksmöglichkeiten für das Innen- und Außendesign steigert.

La calidez de un ambiente vivido, la autenticidad de lugares que nacen a una nueva vida, la sobria elegancia de la recuperación industrial son los valores evocados por la colección Boost Pro que añade nuevas tonalidades cálidas al efecto hormigón, aumentando su potencial expresivo para el diseño de interiores y exteriores.

Тепло пространств, где долго жили или работали, аутентичность мест, которые возвращаются к новой жизни, строгая элегантность старых промышленных материалов – вот, что лежит в основе коллекции Boost Pro. Коллекция окрашивает рисунок цемента в новые, теплые тона, позволяя тем самым стильно украшать им как внутренние, так и наружные пространства.





# PORCELAIN AND WALL TILES: A SAFE CHOICE

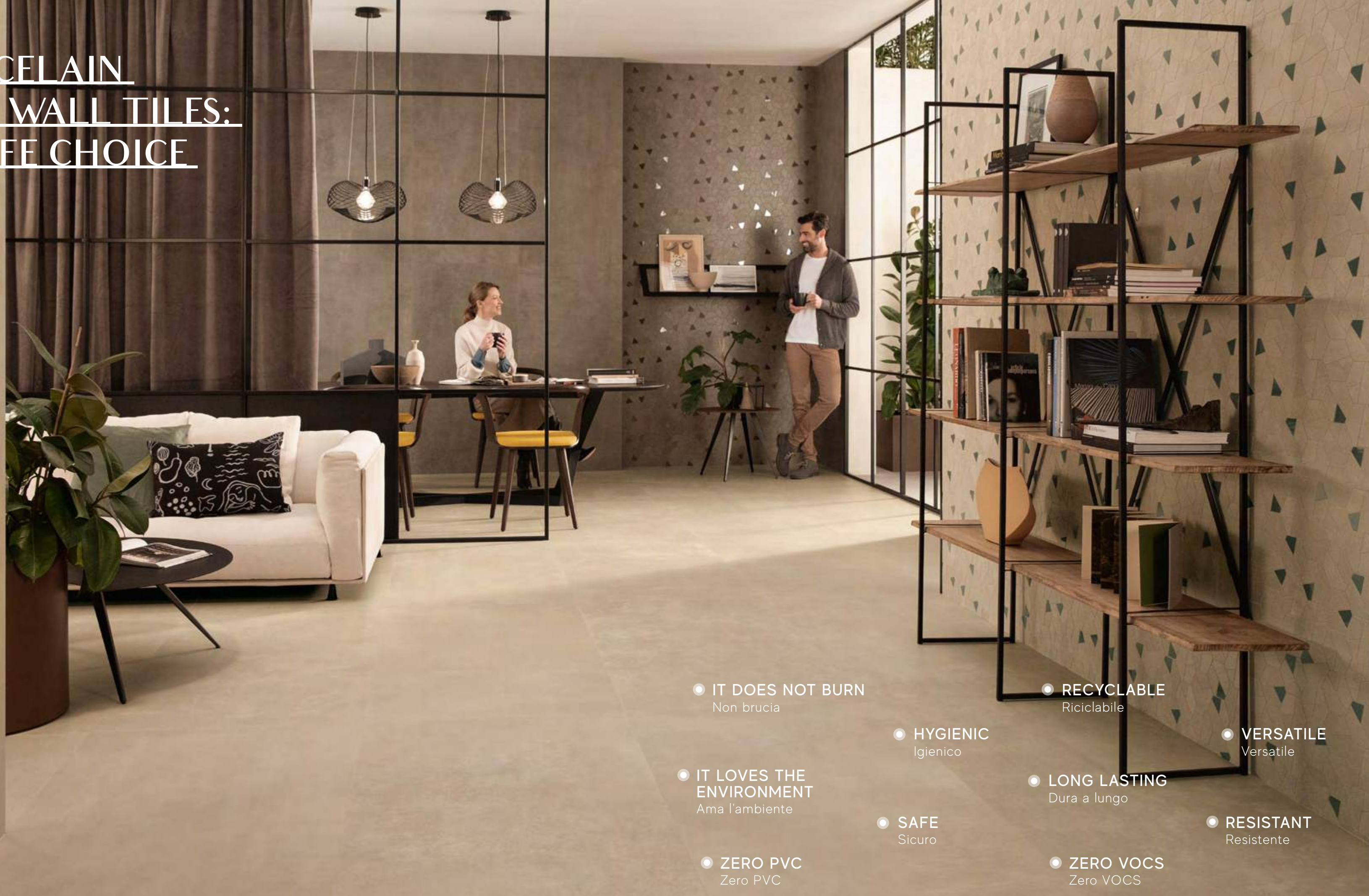

● IT DOES NOT BURN  
Non brucia

● RECYCLABLE  
Riciclabile

● HYGIENIC  
Igienico

● VERSATILE  
Versatile

● IT LOVES THE ENVIRONMENT  
Ama l'ambiente

● LONG LASTING  
Dura a lungo

● SAFE  
Sicuro

● RESISTANT  
Resistente

● ZERO PVC  
Zero PVC

● ZERO VOCS  
Zero VOCS



# WARM SHADES FOR A WIDER COLOR RANGE

## PORCELAIN TILE RANGE

- ① Boost Pro **Ivory**
- ② Boost Pro **Cream**
- ③ Boost Pro **Clay**
- ④ Boost Pro **Taupe**
- ⑤ Boost Pro **Tobacco**

Boost Pro complements the color range of the Boost collection adding five warm shades on the same surface, thus creating a unique color palette in terms of breadth and variety.

Boost Pro integra la gamma colori della collezione Boost con cinque tonalità calde, realizzate sulla stessa struttura di superficie, dando così vita a una palette cromatica unica per ampiezza e varietà.

Boost Pro intègre la gamme des couleurs de la collection Boost avec cinq tonalités chaudes, réalisées sur la même structure superficielle, en donnant ainsi naissance à une palette chromatique unique de par son éventail et sa variété.

Boost Pro ergänzt das Sortiment der Kollektion Boost mit fünf warmen Farben und der gleichen Oberflächenstruktur. Das Resultat ist eine in ihrer Vielfalt einzigartige Farbpalette.

Boost Pro integra la gama de colores de la colección Boost con cinco tonalidades cálidas creadas con la misma estructura de superficie, definiendo una paleta de colores única en cuanto a amplitud y variedad.

Boost Pro пополняет цветовую гамму коллекции Boost пятью теплыми тонами, сохраняя при этом ту же фактуру поверхности. В результате получилась широкая и уникальная по разнообразию палитра.

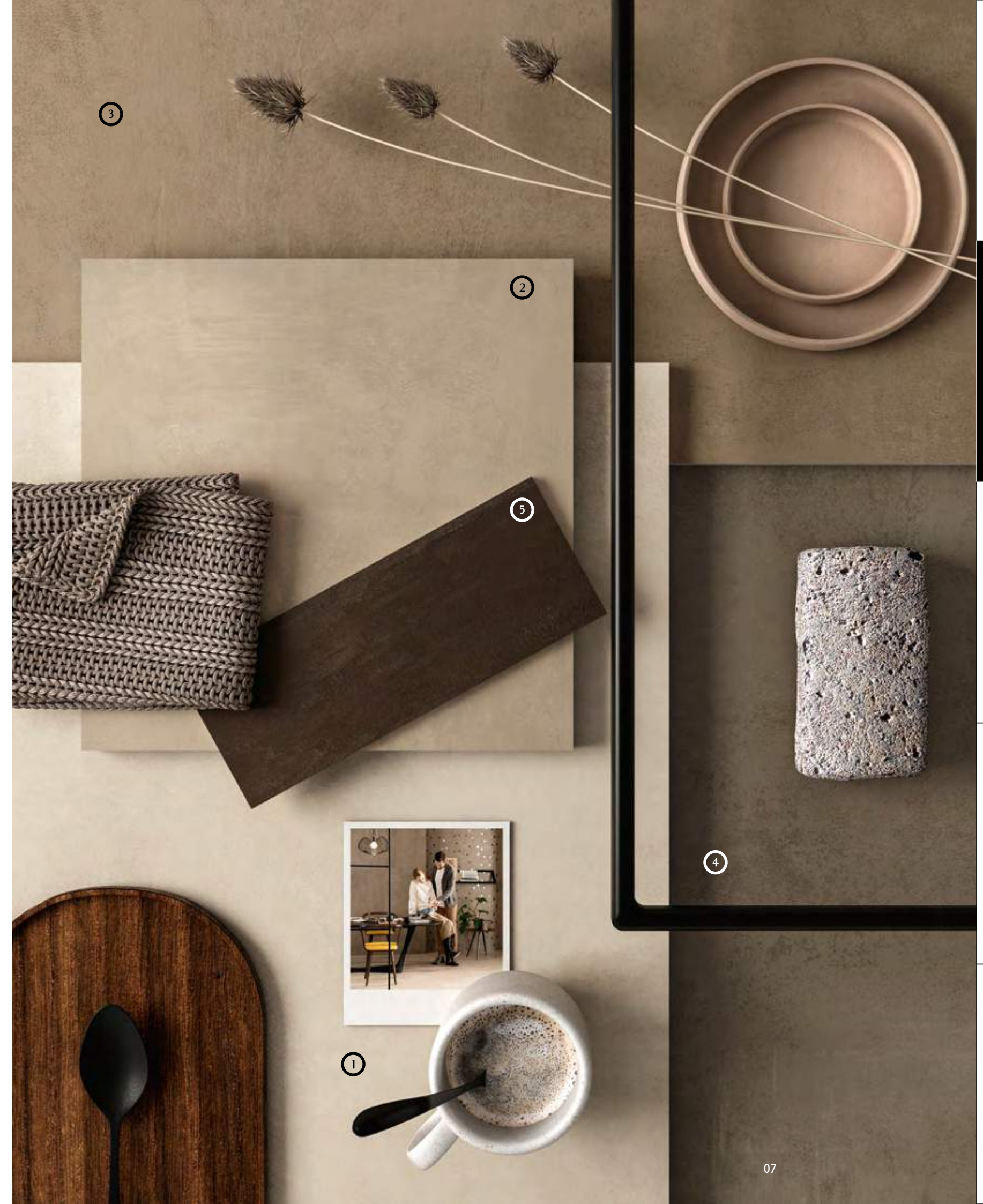



# CREATIVE HUES TO BRIGHTEN INTERIOR WALLS

## WALL TILE RANGE

- ① Boost Pro Ivory
- ② Boost Pro Cream
- ③ Boost Pro Clay
- ④ Boost Pro Powder Blue
- ⑤ Boost Pro Mustard
- ⑥ Boost Pro 3DWall Urban\*

On walls, the dusty accents of the colors Mustard and Powder Blue make it possible to create creative combinations with a strong personality, also thanks to the availability of striking material and graphic decorations.

A rivestimento, gli accenti polverosi dei colori Mustard e Powder Blue permettono di creare abbinamenti creativi dalla forte personalità, grazie anche alla disponibilità di decori materici e grafici di grande impatto.

Les accents poudreux des coloris Mustard et Powder Blue permettent de créer des associations créatives de grand caractère, grâce également à la disponibilité de décors aux graphismes et aux textures de grand impact.

\* 3Dwall Urban colors: Ivory, Clay, Powder Blue

An der Wand erlauben die staubigen Akzente der Farben Mustard und Powder Blue kreative Kombinationen von starker Persönlichkeit, wozu auch das Angebot höchst effektvoller stofflicher und grafischer Dekore beiträgt.

Como revestimiento, los acentos empolvados de los colores Mustard y Powder Blue permiten crear combinaciones creativas con una fuerte personalidad, también gracias a la disponibilidad de decoraciones gráficas y con materiales de gran impacto.

Пыльные акценты цветов Mustard и Powder Blue позволяют выстроить на стенах яркие креативные контрасты, которые можно подчеркнуть эффектными декоративными элементами.

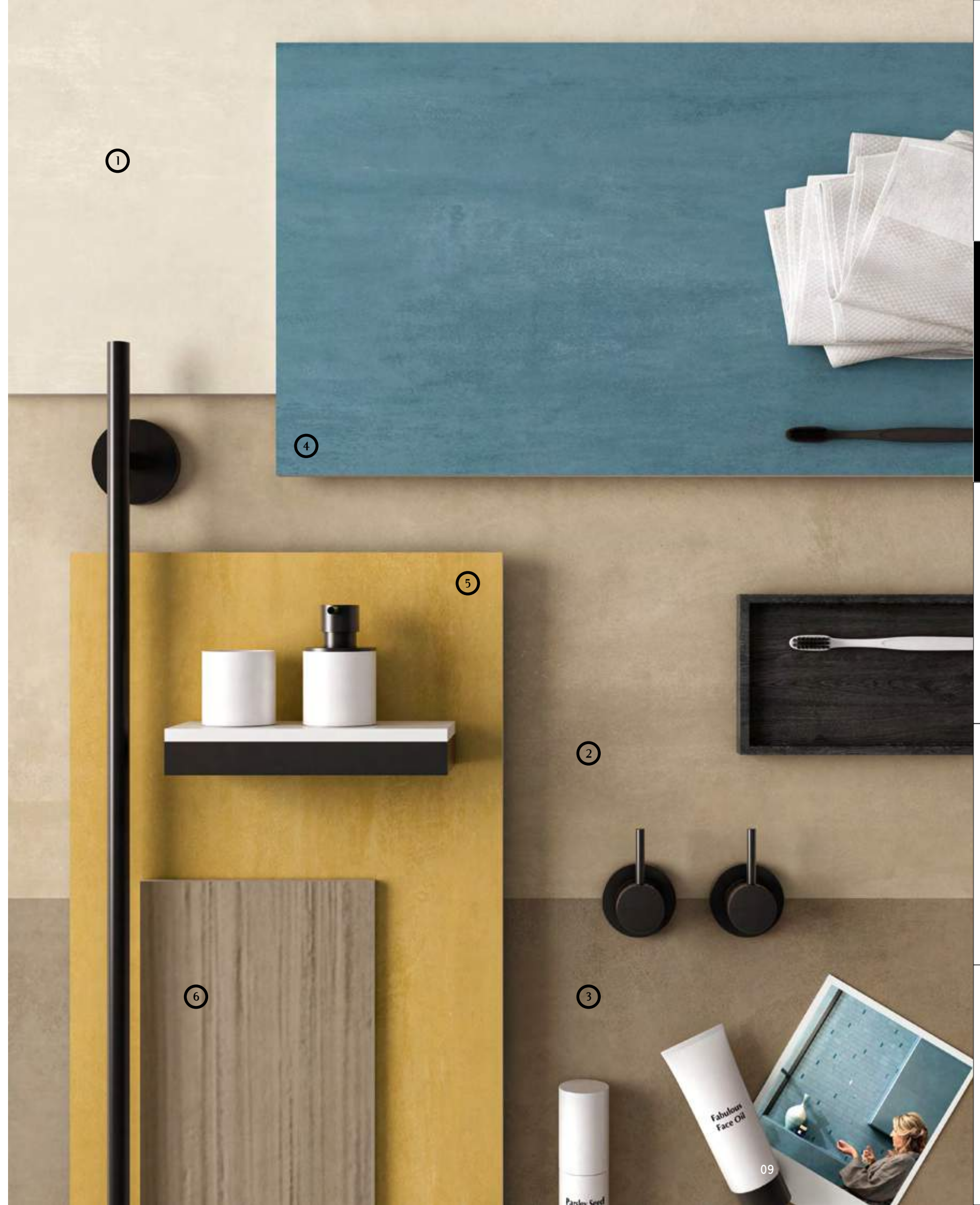



# EXPAND YOUR DESIGN POSSIBILITIES

The wide selection of formats in the Boost Pro range, the presence of a Grip finish, and the 20 mm thickness make it possible to design coordinated indoor-outdoor projects with a consistent look.

L'ampiezza dei formati della gamma Boost Pro, la presenza della finitura Grip e dello spessore 20 mm consentono la realizzazione di progetti coordinati total look indoor-outdoor.

Le vaste choix de formats de la gamme Boost Pro, la présence de la finition Grip et de l'épaisseur de 20 mm permettent de réaliser des projets coordonnés total look indoor-outdoor.

Die große Formatauswahl der Serie Boost Pro, die Oberflächenversion Grip und die Stärke 20 mm erlauben die Ausführung von aufeinander abgestimmten Projekten im Total Look für Indoor und Outdoor.

La amplitud de los formatos de la gama Boost Pro, la presencia del acabado Grip y del espesor de 20 mm permiten crear proyectos combinando un aspecto total look entre diseño interior y el exterior.

Большое количество форматов гаммы Boost Pro, наличие противоскользящего варианта поверхности Grip и толщины 20 мм дают возможность укладывать коллекцию внутри дома и на улице и придать тем самым всему проекту эффектную стилистическую цельность.

## ① Porcelain Tiles for Floors and Walls

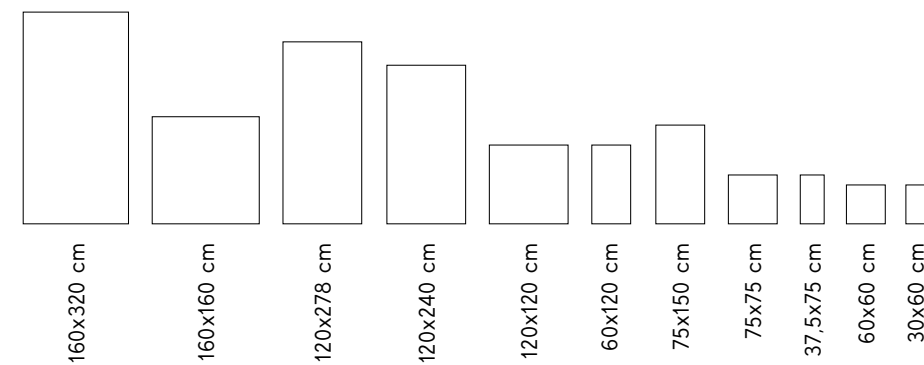

## ② Tiles for Wall Coverings

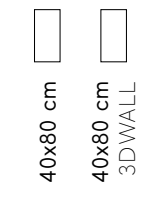

## ③ Porcelain Tiles for Outdoor and Wet Areas

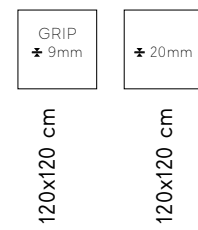



# LARGE SIZES. THE DIMENSION OF CONTEMPORARY DESIGN

## AVAILABLE SIZES

- ① 160x320 cm  
± 6mm  
Available in: Clay, Taupe
  - ② 160x160 cm  
± 6mm  
Available in: Clay, Taupe
  - ③ 120x278 cm  
± 6mm  
Available in: all colors
  - ④ 120x240 cm  
± 9mm  
Available in: all colors
  - ⑤ 120x120 cm  
± 6/9mm  
Available in: all colors
- 120x120 cm  
± 20mm  
Available in: Cream, Clay, Taupe, Tobacco

Atlas Concorde's large-format porcelain tiles are ideal for residential and commercial applications, their extra-large dimensions amplify the perception of living space.

Il gres porcellanato in grande formato di Atlas Concorde è ideale per applicazioni residenziali e commerciali, dove le dimensioni extra large amplificano la percezione dello spazio abitativo.

Le grès cérame grands formats d'Atlas Concorde est la solution idéale pour les applications résidentielles et commerciales, où les très grands formats intensifient la perception de l'espace de vie.

Das großformatige Feinsteinzeug von Atlas Concorde ist ideal im Wohnungs- und Gewerbebau, wo die großen Dimensionen die Wahrnehmung des Raums steigern.

El gres porcelánico en formato grande de Atlas Concorde es ideal para aplicaciones residenciales y comerciales, donde las dimensiones extra-grandes amplifican la percepción del espacio vital.

Благодаря крупноформатному керамограниту от Atlas Concorde домашние и коммерческие пространства визуально кажутся намного больше.





# DECORATIONS THAT AMP UP INTERIORS



Boost Pro features three decorations for large slabs, offering pictorial and material solutions that interpret every environment of contemporary living with personality.

Boost Pro presenta tre decori dedicati alle grandi lastre, caratterizzati da soluzioni pittoriche e materiche che interpretano con personalità ogni ambiente dell'abitare contemporaneo.

Boost Pro présente trois décors dédiés aux grands formats, caractérisés par des solutions picturales et de matières qui interprètent avec caractère tous les espaces de l'habitat contemporain.



Boost Pro präsentiert drei den großen Platten gewidmete Dekore mit malerischen und stofflichen Motiven, die jedes moderne Wohnambiente mit viel Persönlichkeit interpretieren.

Boost Pro presenta tres decoraciones dedicadas a grandes placas, caracterizadas por soluciones pictóricas y materiales que interpretan con personalidad cada ambiente de la vida contemporánea.

Для крупноформатных плит Boost Pro доступны три декора с фактурной живописной поверхностью, способной красочно индивидуализировать любое помещение современного дома.



INDEX

OVERVIEW

SPACES

RANGE

TECH. SPECS



# AN URBAN-CHIC CONCEPT FOR THE BATHROOM



Boost Pro wall tiles – also available in the 3D Urban version – make it possible to design bathroom and wellness spaces with vibrant colors and atmospheres with a metropolitan elegance.

Il rivestimento di Boost Pro, disponibile anche nella versione 3D Urban, consente di realizzare spazi bagno e wellness con colori energici e atmosfere di eleganza metropolitana.

Le revêtement mural de Boost Pro, également disponible dans la version 3D Urban, permet de réaliser des salles de bains ou des espaces de bien-être aux coloris vitaminés, empreints d'une atmosphère de grande élégance urbaine.

Der auch in der Version 3D Urban erhältliche Wandbelag von Boost Pro erlaubt die Gestaltung von Bad- oder Wellnessbereichen in kräftigen Farben und einer eleganten Großstadtatmosphäre.

El revestimiento de Boost Pro, también disponible en la versión 3D Urban, permite crear ambientes de baño y bienestar con colores energicos y atmósferas de elegancia metropolitana.

Настенная плитка Boost Pro, доступная также в варианте 3D Urban, позволяет раскрасить ванные комнаты и велнес-интерьеры в энергичные цвета и придать им элегантную урбанистичность





# LIVING IN THE CITY



URBAN LOFT

INDEX

OVERVIEW

SPACES

RANGE

TECH. SPECS

The collection makes it possible to decorate large interiors thanks to a wide range of extra-large sizes that reproduce the strong personality of concrete while minimizing joints.

La collezione consente di rivestire interni di grandi dimensioni grazie a una gamma ampia di formati extralarge che riproducono la personalità forte del cemento riducendo al minimo le fughe.

La collection permet de revêtir les intérieurs spacieux grâce à une vaste gamme de formats extralarge qui apportent le grand caractère du ciment en permettant de minimiser les joints.

Mit ihrer großen Auswahl an Extralarge-Formaten, die die starke Persönlichkeit des Zements reproduzieren und die Fugen auf ein Minimum reduzieren, ist die Kollektion perfekt für die Verkleidung großer Innenräume.

La colección permite revestir interiores de grandes tamaños gracias a una amplia gama de formatos extralarge que reproducen la fuerte personalidad del hormigón, al tiempo que reducen al mínimo las juntas.

Коллекция великолепно подходит для оформления больших интерьеров благодаря широкой гамме крупных форматов, которые искусно воссоздают сильный характер цемента и сводят к минимуму количество швов.

atlas concorde





atlas concorde

METROPOLITAN APPEAL



atlas concorde



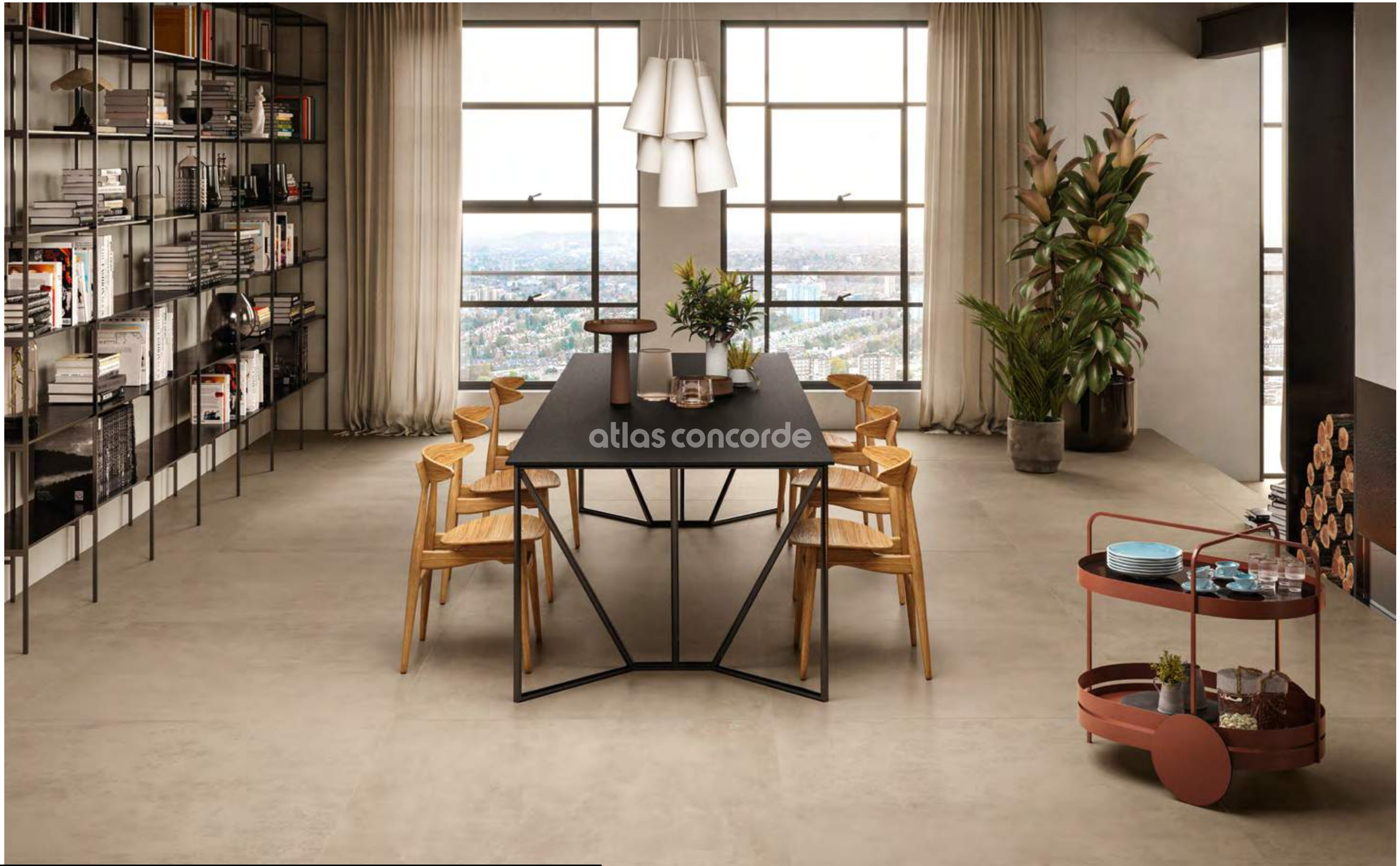

THE SLIGHT TROVELED  
CONCRETE EFFECT EVOKES  
THE AUTHENTICITY OF A  
HANDMADE SURFACE.

L'EFFETTO CEMENTO  
LEGGERMENTE "SPATOLATO"  
EVOCA L'AUTENTICITÀ DEL  
"FATTO A MANO".

L'EFFET CIMENT  
LÉGÈREMENT "BROSSÉ"  
ÉVOQUE L'AUTENTICITÉ  
DU "FAIT MAIN".

DIE LEICHT "GESPACHELTE"  
WIRKENDE ZEMENTOPTIK  
EVOZIERT AUTHENTISCHE  
„HANDARBEIT“.

EL EFECTO HORMIGÓN  
LIGERAMENTE «ESPATULADO»  
EVOCA LA AUTENTICIDAD DE  
LO «HECHO A MANO».

ЭФФЕКТ СЛЕГКА  
РАЗГЛАЖЕННОГО ШПАТЕЛЕМ  
ЦЕМЕНТА ДАЕТ ОЩУЩЕНИЕ  
РУЧНОЙ РАБОТЫ.



THE PLEASURE OF AUTHENTICITY







atlas concorde



atlas concorde

URBAN LOFT

AUTHENTIC WARMTH



LARGE FORMAT DECORATIONS  
INSPIRED BY WALLPAPER  
ARE PERFECT FOR THE  
WALLS OF BATHROOMS  
AND SHOWERS.

I DECORI IN GRANDE FORMATO,  
ISPIRATI ALLE CARTE DA  
PARATI, PERMETTONO DI  
RIVESTIRE ANCHE LE PARETI  
DI BAGNI E DOCCE.

LES DÉCORS GRAND FORMAT  
QUI S'INSPIRENT DU PAPIER-PEINT  
PERMETTENT ÉGALEMENT DE  
REVÊTIR LES MURS DE SALLES DE  
BAINS OU DE CABINES DE DOUCHE.

DIE GROSSFORMATIGEN, AN  
TAPETEN INSPIRIERTEN  
DEKORE EIGNEN SICH AUCH  
ZUR VERKLEIDUNG VON  
BAD- UND DUSCHWÄNDEN.

LAS DECORACIONES EN FORMATO  
GRANDE, INSPIRADAS EN EL  
PAPEL PINTADO, TAMBIÉN  
PERMITEN REVESTIR PAREDES  
DE BAÑOS Y DUCHAS.

КРУПНОФОРМАТНЫЕ ДЕКОРЫ,  
ИМИТИРУЮЩИЕ ОБОИ,  
ПОДХОДЯТ ТАКЖЕ ДЛЯ  
ОБЛИЦОВКИ СТЕН ВАННЫХ  
КОМНАТ И ДУШЕВЫХ КАБИН.



**SURFACES DISPLAYED**

- |  |  |
|--|--|
| <b>PORCELAIN TILES</b>   | <b>PORCELAIN TILE DECOR</b>  |
| <b>Clay</b> Matte/Matt<br>120x120 cm   47 <sup>1</sup> / <sub>4</sub> "x47 <sup>1</sup> / <sub>4</sub> "     | <b>Grove</b> 6 mm<br>120x278 cm   47 <sup>1</sup> / <sub>4</sub> "x109 <sup>1</sup> / <sub>2</sub> "               |
| <b>Ivory</b> Matte/Matt<br>120x278 cm   47 <sup>1</sup> / <sub>4</sub> "x109 <sup>1</sup> / <sub>2</sub> "   | <b>ATLAS PLAN</b><br>Table - Countertop  |
| <b>Tobacco</b> Matte/Matt<br>120x278 cm   47 <sup>1</sup> / <sub>4</sub> "x109 <sup>1</sup> / <sub>2</sub> " | <b>Nero Zimbabwe</b> Matte/Matt<br>162x324 cm   63 <sup>3</sup> / <sub>4</sub> "x127 <sup>1</sup> / <sub>2</sub> " |





# URBAN CHIC ATTITUDE



atlas concorde

INDUSTRIAL LIVING

INDEX

OVERVIEW

SPACES

RANGE

TECH. SPECS

Boost Pro features five warm shades with a troweled concrete effect in line with the latest trends in interior design. The availability of outdoor surfaces allows for coordinated indoor-outdoor projects.

Boost Pro propone cinque tonalità calde effetto cemento spatolato in linea con i trend più attuali dell'interior design. La disponibilità di superfici per l'esterno consente progetti coordinati indoor-outdoor.

Boost Pro propose cinq tonalités chaudes effet ciment brossé, en accord avec les dernières tendances de la décoration d'intérieur. La disponibilité de surfaces pour l'espace extérieur permet de réaliser des projets indoor-outdoor coordonnés.

Boost Pro bietet fünf warme Farbtöne in gespachtelter Zementoptik, ganz im aktuellen Trend des Innendesigns. Die Beläge sind auch für das Outdoor erhältlich und erlauben die Gestaltung passend aufeinander abgestimmter Innen- und Außenbereiche.

Boost Pro propone cinco tonalidades cálidas con efecto hormigón espatulado en línea con las últimas tendencias en diseño de interiores. La disponibilidad de superficies para exteriores permite realizar proyectos donde se combinan los ambientes interiores con los exteriores.

Boost Pro предлагает пять теплых тонов с имитацией разглаженного шпателем цемента в стиле последних трендов интерьерного дизайна. Наличие уличного варианта плиток позволяет придать внутренним и наружным пространствам гармоничную цельность.





atlas concorde

PERFECT REPRODUCTION OF REAL CONCRETE WITH THE BENEFITS OF PORCELAIN TILES: STAIN RESISTANCE, IMPACT RESISTANCE AND IMPERMEABILITY.

PERFETTA RIPRODUZIONE DEL CEMENTO VERO CON I VANTAGGI DEL GRÉS PORCELLANATO: RESISTENZA ALLE MACCHIE, AGLI URTI E IMPERMEABILITÀ.

REPRODUCTION PARFAITE DU VRAI CIMENT AVEC TOUS LES AVANTAGES DU GRÉS CÉRAMÉ : RÉSISTANCE AUX TACHES, AUX CHOCS ET ÉTANCHÉITÉ.

PERFEKTE NACHBILDUNG VON ECHTEM ZEMENT MIT DEN VORTEILEN DES FEINSTEINZEUGS: FLECKENBESTÄNDIG, STOSSFEST UND WASSERUNDURCHLÄSSIG.

PERFECTA REPRODUCCIÓN DEL HORMIGÓN REAL CON LAS VENTAJAS DEL GRÉS PORCELÁNICO: RESISTENCIA A LAS MANCHAS, AL IMPACTO E IMPERMEABILIDAD.

ПОКРЫТИЕ С ТОЧНЫМ ВОСПРОИЗВЕДЕНИЕМ РИСУНКА ЦЕМЕНТА, НО С ПРЕИМУЩЕСТВАМИ КЕРАМОГРАНИТА, ТАКИМИ КАК СТОЙКОСТЬ К ПЯТНАМ, УДАРАМ И ВЛАГЕ.



atlas concorde

INDUSTRIAL LIVING

INDEX

OVERVIEW

SPACES

RANGE

TECH. SPECS





atlas concorde



atlas concorde

WARM EARTHY SURFACES





MOSAICO HEX  
ENHANCES THE WALLS  
WITH REFLECTIONS OF  
COLORED MURANO  
GLASS TILES.

MOSAICO HEX  
ARRICCHISCE LE PARETI  
CON I RIFLESSI DI  
TESSERE COLORATE IN  
VETRO DI MURANO.

MOSAICO HEX ENRICHIT  
LES MURS GRÂCE AUX  
REFLETS DES TESSELLES  
COLORÉES EN VERRE  
DE MURANO.

MOSAICO HEX  
VERSCHÖNERT DIE WÄNDE  
MIT DEN REFLEXEN BUNTER  
MOSAIKSTEINCHEN AUS  
MURANO-GLAS.

MOSAICO HEX ENRIQUECE  
LAS PAREDES CON LOS  
REFLEJOS DE TESELAS  
COLORADAS DE VIDRIO  
DE MURANO.

MOSAICO HEX  
УКРАШАЕТ  
СТЕНЫ БЛЕСКОМ  
КУСОЧКОВ  
МУРАНСКОГО СТЕКЛА.







atlas concorde

## SURFACES DISPLAYED

### PORCELAIN TILES

**Cream** Matte/Matt  
75x150 cm | 29 1/2"x59"

**Taupe** Matte/Matt  
75x150 cm | 29 1/2"x59"

**Ivory** Grip/Grip  
120x120 cm | 47 1/4"x47 1/4"

### PORCELAIN TILE DECORS

**Cream Mosaico Hex Blue**  
25x28,5 cm | 9 7/8"x11 1/4"

**Taupe Mosaico Hex Coffee**  
25x28,5 cm | 9 7/8"x11 1/4"



INDUSTRIAL LIVING

atlas concorde

INDEX

OVERVIEW

SPACES

RANGE

TECH. SPECS



# WHERE STYLE IS WELCOME



atlas concorde

The 160x320 cm format is perfect in large spaces, even with high ceilings, reducing the presence of joints and cladding any architectural element.

Il formato 160x320 cm è perfetto in grandi spazi anche in presenza di altezze elevate, riducendo la presenza delle fughe e rivestendo ogni elemento architettonico.

Le format 160x320 cm est parfait pour de grands espaces, également dans le cas de hautes hauteurs sous plafond. Il réduit la présence des joints et permet de revêtir chaque élément architectural.

Das Format 160x320 cm ist perfekt für große und auch hohe Flächen, mit weniger Fugen sowie zur Verkleidung baulicher Elemente.

El formato 160x320 cm es perfecto para grandes espacios incluso con elevadas alturas, reduciendo la presencia de juntas y revistiendo todo elemento arquitectónico.

Формат 160x320 идеален для больших пространств с высокими потолками, поскольку минимизирует количество швов и эффектно покрывает любые архитектурные элементы.





atlas concorde



atlas concorde





atlas concorde

LARGE FORMAT PORCELAIN TILES ARE IDEAL IN HIGH-TRAFFIC ENVIRONMENTS THANKS TO THEIR EASE OF CLEANING.

IL GRES PORCELLANATO DI GRANDE FORMATO È IDEALE IN AMBIENTI CON UN'ELEVATA PRESENZA DI VISITATORI GRAZIE ALLA FACILITÀ DI PULIZIA.

LE GRÈS CÉRAME GRAND FORMAT EST PARFAIT POUR LES ESPACES QUI ACCUEILLEN UN GRAND NOMBRE DE VISITEURS GRÂCE À SON EXTRÊME FACILITÉ DE NETTOYAGE.

DAS GROSSFORMATIGE FEINSTEINZEUG IST AUSGESPROCHEN REINIGUNGSFREUNDLICH UND DAMIT IDEAL FÜR STARK FREQUENTIERTE BEREICHEN.

EL GRES PORCELÁNICO DE GRAN FORMATO ES IDEAL PARA AMBIENTES CON IMPORTANTE PRESENCIA DE VISITANTES GRACIAS A SU FACILIDAD DE LIMPIEZA.

КЕРАМОГРАНИТ БОЛЬШОГО ФОРМАТА ИДЕАЛЕН ДЛЯ ИНТЕРЬЕРОВ С БОЛЬШИМ КОЛИЧЕСТВОМ ПОСЕТИТЕЛЕЙ БЛАГОДАРЯ ПРОСТОТЕ В УХОДЕ.





COZY DESIGN







### SURFACES DISPLAYED

PORCELAIN TILES  
**Taupe** Matte/Matt  
 160x320 cm | 63"x126"

**Clay** Matte/Matt  
 160x160 cm | 63"x63"

Boost **White** Matte/Matt  
 120x278 cm | 47 1/4"x109 1/2"

Marvel **Calacatta Extra**  
 Polished/Lappato  
 160x320 cm | 63"x126"





## A MIX OF STYLES

atlas concorde

The urban character of the concrete effect stands out in a metropolitan café. The Paint decoration covers the wall with the intensity of surfaces marked by time.

Il carattere urban dell'effetto cemento diventa protagonista in un caffè metropolitano. Il decoro Paint propone a tutta parete l'intensità di superfici segnate dal tempo.

Le caractère urban de l'effet ciment devient le protagoniste d'un café urbain. Le décor Paint propose l'intensité de surfaces murales marquées par le temps.

Großstädtisch wirkende Zementoptik im Blickpunkt eines Cafés in der Stadt. Das Dekor Paint bietet über die ganze Wand eine eindrucksvolle, wie von der Zeit gezeichnete Fläche.

El carácter urban del efecto hormigón se convierte en protagonista de un café metropolitano. La decoración Paint brinda la intensidad de las superficies marcadas por el tiempo a toda la pared.

Урбанистический характер цемента становится главным украшением городского кафе. Декор Paint придает всей стене шарм отмеченных временем поверхностей.





HARMONIC CONTRASTS



atlas concorde





atlas concorde

**SURFACES DISPLAYED**

- PORCELAIN TILES
  - Tobacco** Matte/Matt  
120x120 cm | 47<sup>1</sup>/<sub>4</sub>"x47<sup>1</sup>/<sub>4</sub>"
  - Tobacco** Matte/Matt  
120x278 cm | 47<sup>1</sup>/<sub>4</sub>"x109<sup>1</sup>/<sub>2</sub>"
- COUNTER
  - Boost **Smoke** Matte/Matt  
120x278 cm | 47<sup>1</sup>/<sub>4</sub>"x109<sup>1</sup>/<sub>2</sub>"
- Taupe** Outdoor  $\pm$  20 mm  
120x120 cm | 47<sup>1</sup>/<sub>4</sub>"x47<sup>1</sup>/<sub>4</sub>"
- PORCELAIN TILE DECOR
  - Paint**  $\pm$  6 mm  
120x278 cm | 47<sup>1</sup>/<sub>4</sub>"x109<sup>1</sup>/<sub>2</sub>"
  - Leaves**  $\pm$  6 mm  
120x278 cm | 47<sup>1</sup>/<sub>4</sub>"x109<sup>1</sup>/<sub>2</sub>"

USED ON WALLS, LARGE SLAB DECORATIONS GUARANTEE HYGIENIC, HEALTHY SURFACES.

USATO COME UN PARATO, IL DECORO SU GRANDE LASTRA GARANTISCE IGIENICITÀ E SALUBRITÀ DELLE SUPERFICI.

UTILISÉ TEL UN SYSTÈME, LE DÉCOR DES GRANDES PLAQUES GARANTIT L'HYGIÈNE ET LA SALUBRITÉ DES SURFACES.

DAS DEKOR AUF DER GROSSEN PLATTE WIRKT WIE EINE TAPETE UND GARANTIERT DABEI HYGIENISCHE UND GESUNDE OBERFLÄCHEN.

USADO COMO EMPAPELADO, LA DECORACIÓN EN UNA GRAN LOSA QUE GARANTIZA SUPERFICIES HIGIÉNICAS Y SALUBRIDAD.

ПОХОЖИЙ НА ОБОИ КРУПНОФОРМАТНЫЙ ДЕКОР ОБЕСПЕЧИВАЕТ ВЫСОКУЮ ГИГИЕНИЧНОСТЬ ПОВЕРХНОСТЕЙ.



atlas concorde



# LIVING BY THE SEA



atlas concorde

A villa overlooking the ocean is a perfect example of how Boost Pro can best interpret the needs of a residential total look by harmonizing floors, walls, and decorations, both indoors and out.

Una villa sull'oceano è l'esempio perfetto di come Boost Pro possa interpretare al meglio le esigenze di total look residenziale armonizzando pavimenti, rivestimenti e decori, sia in interno sia in esterno.

Une maison sur l'océan est l'exemple parfait de comment Boost Pro peut interpréter au mieux les exigences d'un total look résidentiel, en harmonisant les sols, les murs et les décors, tant en intérieur qu'en extérieur.

Eine Villa am Ozean ist das perfekte Beispiel dafür, wie Boost Pro den Total Look im Wohnungsbau gestaltet: Boden, Wand und Dekore, innen und außen.

Una villa frente al mar es el ejemplo perfecto de cómo Boost Pro puede interpretar en el mejor modo un total look en una vivienda, armonizando pavimentos, revestimientos y decoraciones, tanto en su interior como exterior.

Вилла на берегу океана – яркий пример того, как Boost Pro может придать дому стильную цельность, украсив полы, стены, предметы обстановки внутри помещений и на улице.





atlas concorde

THE AVAILABILITY OF SPECIAL  
PIECES FOR USE AROUND  
THE POOL COMPLETES  
THE COLLECTION.

ALL'ESTERNO, LA DISPONIBILITÀ  
DEI PEZZI SPECIALI PER IL  
BORDO PISCINA COMPLETA IL  
PROGETTO STILISTICO.

À L'EXTÉRIEUR, LA DISPONIBILITÉ  
DES PIÈCES SPÉCIALES POUR  
LE BORD DE PISCINE COMPLÈTE  
LE PROJET STYLISTIQUE.

IM FREIEN WIRD DAS  
STILPROJEKT DURCH  
FORMSTÜCKE FÜR DEN  
POOLRAND KOMPLETTIERT.

EN EL EXTERIOR, LA DISPONIBILIDAD  
DE PIEZAS ESPECIALES PARA EL  
BORDE DE LA PISCINA COMPLETA  
EL PROYECTO ESTILÍSTICO.

УЛИЧНЫЕ СПЕЦИАЛЬНЫЕ  
ЭЛЕМЕНТЫ ДЛЯ ОФОРМЛЕНИЯ КРАЕВ  
БАСЕЙНОВ ПРИДАЮТ ПРОЕКТУ  
СТИЛИСТИЧЕСКУЮ ЗАВЕРШЕННОСТЬ.



atlas concorde





**SURFACES DISPLAYED**

- |   |  |
|---|--|
| <b>PORCELAIN TILES</b>  | <b>PORCELAIN TILE DECOR</b>                            |
| <b>Clay Matte/Matt</b><br>120x120 cm   47 1/4" x 47 1/4"      | <b>Paint</b> ± 6 mm<br>120x278 cm   47 1/4" x 109 1/2" |
| <b>Clay Outdoor</b> ± 20 mm<br>120x120 cm   47 1/4" x 47 1/4" |  |



INDEX

OVERVIEW

SPACES

RANGE

TECH. SPECS



# THE STRENGTH OF ELEGANCE

FOREST VILLA

atlasconcorde

Porcelain tiles with a 20 mm thickness guarantee anti-slip performance that is much higher than the minimum values required by current standards.

Il gres porcellanato in 20 mm di spessore garantisce prestazioni antiscivolo molto superiori ai valori minimi richiesti dalla norma.

Le grès cérame épaisseur 20 mm garantit des prestations antiglisse dépassant considérablement les valeurs minimum demandées par la réglementation.

Das 20 mm starke Feinsteinzeug garantiert eine wesentlich höhere Rutschfestigkeit als die von den Richtlinien vorgeschriebenen Mindestwerte.

El gres porcelánico de 20 mm de espesor garantiza un rendimiento antideslizante 20 muy por encima de los valores mínimos requeridos por la norma.

Показатели сопротивления скольжению керамогранита толщиной 20 мм намного выше минимальных значений, установленных стандартом.

## SURFACES DISPLAYED

PORCELAIN TILES

**Tobacco Outdoor** 20 mm  
120x120 cm | 47<sup>1</sup>/<sub>4</sub>"x47<sup>1</sup>/<sub>4</sub>"

INDEX

OVERVIEW

SPACES

RANGE

TECH. SPECS



# EARTHY AND DEEP BLUE



atlas concorde

The dusty tone of the Powder Blue wall tile defines the bathroom's strong personality, ideal for use on its own or together with the lighter shades of the collection and other materials such as wood and metal.

Il tono polveroso del rivestimento Powder Blue definisce la personalità forte del bagno, ideale per un utilizzo totale o in abbinamento ai colori più chiari della collezione e ad altri materiali come legno e metallo.

Le ton poudreux du revêtement Powder Blue définit la forte personnalité de la salle de bains, idéal pour une utilisation totale ou en association aux teintes plus claires de la collection et à d'autres matières comme le bois et le métal.

Der satubige Farbton des Wandbelags Powder Blue definiert die starke Persönlichkeit des Bads. Ideal für die Verlegung an allen Wänden oder im Mix mit den helleren Farben der Kollektion, oder mit anderen Materialien wie Holz oder Metall.

El tono empolvado del revestimiento Powder Blue define la fuerte personalidad del baño, ideal para un uso total o en combinación con los colores más claros de la colección y otros materiales como madera y metal.

Пыльный настенный оттенок Powder Blue придает ванной комнате яркий характер. Может быть использован самостоятельно или в сочетании с более светлыми тонами и другими материалами, такими как дерево или металл.





atlas concorde

INTENSE CHOICE



atlas concorde





RECTANGULAR MINIBRICK PRO  
TILES FEATURE REFLECTIVE  
INSERTS FOR SPARKLING  
EFFECTS ON THE WALLS.

IL MINIBRICK PRO A TESSERE  
RETTANGOLARI È IMPREZIOSITO  
DA INSERTI RIFLETTENTI PER  
GIOCHI DI LUCE A PARETE.

LE MINIBRICK PRO AUX TESSELLES  
RECTANGULAIRES EST ENRICHIS  
D'INSERTS RÉFLÉCHISSANTS QUI CRÉENT  
DES JEUX DE LUMIÈRE SUR LE MUR.

DAS MINIBRICK PRO MIT  
RECHTECKIGEN MOSAIKSTEINCHEN  
WIRD DURCH REFLEKTIERENDE  
EINLEGER VEREDELT, DIE AN DER  
WAND LICHTSPIELE ERZEUGEN.

MINIBRICK PRO CON TESELAS  
RECTANGULARES ESTÁ DECORADO  
CON INSERTOS REFLECTANTES PARA  
DAR EFECTOS DE LUZ A LA PARED.

ДЕКОР МИНИБРICK ПРО ИЗ  
ПРЯМОУГОЛЬНЫХ ЭЛЕМЕНТОВ  
ДОПОЛНЕН ГЛЯНЦЕВЫМИ  
ВСТАВКАМИ, РОЖДАЮЩИМИ НА  
СТЕНАХ ПРИЯТНУЮ ИГРУ СВЕТА.





**SURFACES DISPLAYED**

WALL TILES

**Powder Blue**  
40x80 cm | 15<sup>3</sup>/<sub>4</sub>"x31<sup>1</sup>/<sub>2</sub>"

**3D Urban Powder Blue**  
40x80 cm | 15<sup>3</sup>/<sub>4</sub>"x31<sup>1</sup>/<sub>2</sub>"

WALL TILE DECOR

**Powder Blue**  
**Minibrick Pro Ocean**  
29,7x33,3 cm | 11<sup>5</sup>/<sub>8</sub>"x13<sup>1</sup>/<sub>4</sub>"

WALL TRIM TILES

**Powder Blue Corner**  
1,4x40 cm | 5<sup>5</sup>/<sub>8</sub>"x15<sup>3</sup>/<sub>4</sub>"

**Powder Blue Corner A.E.**  
1,4x1,4 cm | 5<sup>5</sup>/<sub>8</sub>"x5<sup>5</sup>/<sub>8</sub>"

PORCELAIN TILES

**Heartwood Brandy** Matte/Matt  
18,5x150 cm | 7<sup>1</sup>/<sub>4</sub>"x59"

**Clay** Matte/Matt  
75x150 cm | 29<sup>1</sup>/<sub>2</sub>"x59"



# COLOR REVOLUTION



Thanks to their light weight and ease of cutting and drilling, white body wall tiles speed up the installation and decoration of numerous rooms in a hotel.

In un progetto alberghiero, il rivestimento in pasta bianca, grazie alla leggerezza e facilità di taglio e foratura, velocizza la posa e la realizzazione di numerosi ambienti.

Dans un projet hôtelier, la légèreté et la facilité de découpe et de perçage des carreaux en pâte blanche, accélère la pose murale et la réalisation des différents espaces.

In einem Hotelprojekt verkürzt der leichte und einfach zu schneidende und zu bohrende, weißscherbige Wandbelag die Verlegezeiten, so dass viele Räume rasch fertiggestellt werden.

En un proyecto de hotel, el revestimiento de pasta blanca, gracias a la ligereza y facilidad de corte y perforación, acelera la colocación y realización de numerosos ambientes.

Настенная плитка из белой глины благодаря небольшому весу и простоте резки и сверления ускоряет монтаж и позволяет быстро оформлять многочисленные интерьеры отеля.





atlas concorde



atlas concorde

PERFETTO PER HOTEL  
THANKS TO THEIR  
EASY CLEANING AND  
MAINTENANCE.

PERFETTO IN HOTEL  
PER LA SEMPLICITÀ  
DI PULIZIA E  
MANUTENZIONE.

PARFAIT POUR LES  
HÔTELS GRÂCE À  
SA GRANDE FACILITÉ  
D'ENTRETIEN.

IDEAL IN HOTELS  
DANK DER EINFACHEN  
REINIGUNG UND  
PFLEGE.

PERFECTO PARA HOTELES  
POR SU SIMPLICIDAD  
DE LIMPIEZA Y  
MANTENIMIENTO.

ИДЕАЛЬНО ДЛЯ  
ОТЕЛЕЙ БЛАГОДАря  
ПРОСТОТЕ ЧИСТКИ  
И УХОДА.





atlas concorde

## SURFACES DISPLAYED

### WALL TILES

**Ivory**  
40x80 cm | 15<sup>3</sup>/<sub>4</sub>"x31<sup>1</sup>/<sub>2</sub>"

**Mustard**  
40x80 cm | 15<sup>3</sup>/<sub>4</sub>"x31<sup>1</sup>/<sub>2</sub>"

### WALL TILE DECOR

**Mustard Minibrick Pro Yellow**  
29,7x33,3 cm | 11<sup>5</sup>/<sub>8</sub>"x13<sup>3</sup>/<sub>4</sub>"

### WALL TRIM TILES

**Ivory Corner**  
1,4x40 cm | 5<sup>5</sup>/<sub>8</sub>"x15<sup>3</sup>/<sub>4</sub>"

**Mustard Corner**  
1,4x40 cm | 5<sup>5</sup>/<sub>8</sub>"x15<sup>3</sup>/<sub>4</sub>"

**Ivory Corner A.E.**  
1,4x1,4 cm | 5<sup>5</sup>/<sub>8</sub>"x2<sup>1</sup>/<sub>8</sub>"

### PORCELAIN TILES

**Ivory Matte/Matt**  
75x150 cm | 29<sup>1</sup>/<sub>2</sub>"x59"

**Taupe Matte/Matt**  
75x150 cm | 29<sup>1</sup>/<sub>2</sub>"x59"



atlas concorde



# EVERYDAY PLEASURE

HOME SPA



atlasconcorde

Thanks to the softness of Boost Pro's enamel, the 3D wall tile is extremely easy to clean.

Il rivestimento 3D, grazie alla morbidezza dello smalto di Boost Pro, si pulisce con estrema facilità.

Grâce à la douceur de l'émail, le revêtement 3D de Boost Pro se nettoie avec une extrême facilité.

Der 3D-Wandbelag lässt sich dank der weichen Glasur von Boost Pro extrem leicht reinigen.

El revestimiento 3D, gracias a la suavidad del esmalte de Boost Pro, es extremadamente fácil de limpiar.

Настенная 3D-плитка Boost Pro благодаря стойкому слою глазури крайне проста в уходе.





THE HIGHEST STANDARD







atlas concorde

**WALL TILES ENSURE  
MAXIMUM HYGIENE:  
THEY PREVENT THE  
PROLIFERATION OF  
MOLD AND BACTERIA.**

IL RIVESTIMENTO  
ASSICURA LA MASSIMA  
IGIENE: IMPEDISCE LA  
PROLIFERAZIONE DI  
MUFFE E BATTERI.

**LE REVÊTEMENT ASSURE  
LA GRANDE HYGIÈNE : IL  
EMPÊCHE LA PROLIFÉRATION  
DE BACTÉRIES ET DE  
MOISSISURES.**

DER WANDBELAG GARANTIERT  
MAXIMALE HYGIENE: ER  
VERHINDERT DEN BEFALL  
MIT SCHIMMEL UND  
BAKTERIEN.

**EL REVESTIMIENTO  
ASEGURA LA MÁXIMA  
HIGIENE: IMPIDE LA  
PROLIFERACIÓN DE MOHO  
Y BACTERIAS.**

НАСТЕННАЯ ПЛИТКА  
ОБЕСПЕЧИВАЕТ  
МАКСИМАЛЬНУЮ ГИГИЕНУ:  
НЕ НЕЙ НЕ РАЗМНОЖАЮТСЯ  
ПЛЕСЕНЬ И БАКТЕРИИ.



atlas concorde





**SURFACES DISPLAYED**

- |  |   |  |
|--|---|--|
| <p><b>WALL TILES</b></p> <p><b>Clay</b><br/>40x80 cm   15<sup>3</sup>/<sub>4</sub>"x31<sup>1</sup>/<sub>2</sub>"</p> <p><b>Ivory</b><br/>40x80 cm   15<sup>3</sup>/<sub>4</sub>"x31<sup>1</sup>/<sub>2</sub>"</p> <p><b>3D Urban Ivory</b><br/>40x80 cm   15<sup>3</sup>/<sub>4</sub>"x31<sup>1</sup>/<sub>2</sub>"</p> <p><b>WALL TILE DECOR</b></p> <p><b>Ivory Minibrick Pro Olive</b><br/>27,7x33,3 cm   11<sup>9</sup>/<sub>8</sub>"x13<sup>1</sup>/<sub>4</sub>"</p> | <p><b>WALL TRIM TILES</b></p> <p><b>Clay Corner</b><br/>1,4x40 cm   5<sup>1</sup>/<sub>8</sub>"x15<sup>3</sup>/<sub>4</sub>"</p> <p><b>PORCELAIN TILES</b></p> <p><b>Cream Matte/Matt</b><br/>75x150 cm   29<sup>1</sup>/<sub>2</sub>"x59"</p> <p><b>Clay Matte/Matt</b><br/>75x150 cm   29<sup>1</sup>/<sub>2</sub>"x59"</p> | <p><b>Ivory Matte/Matt</b><br/>75x150 cm   29<sup>1</sup>/<sub>2</sub>"x59"</p> <p><b>PORCELAIN TILE DECOR</b></p> <p>Heartwood <b>Brandy Tatami</b><br/>18,5x75 cm   7<sup>1</sup>/<sub>4</sub>"x29<sup>1</sup>/<sub>2</sub>"</p> |
|--|---|--|





BOOST PRO

# Porcelain tiles

**COLOURED BODY PORCELAIN TILES - RECTIFIED MONOCALIBER**

GRES PORCELLANATO COLORATO IN MASSA - RETTIFICATO MONOCALIBRO

Grès cérame coloré dans la masse - Rectifié mono-calibre / Durchgefärbtes Feinsteinzeug - Geschliffen einkalibrig /

Gres porcelánico coloreado en masa - Rectificado monocalibre / Керамический гранит окрашенный в массе - Ретифицированный в одном калибре

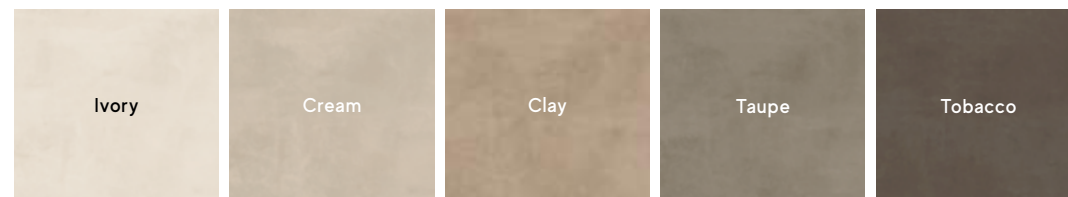

160x320 cm - 63"x126"	± 6 mm			Matte	Matte	
160x160 cm - 63"x63"	± 6 mm			Matte	Matte	
120x278 cm - 47 1/4"x109 1/2"	± 6 mm	Matte	Matte	Matte	Matte	Matte
120x240 cm - 47 1/4"x94 1/2"	± 9 mm	Matte	Matte	Matte	Matte	Matte
120x120 cm - 47 1/4"x47 1/4"	± 6 mm	Matte	Matte	Matte	Matte	Matte
	± 9 mm	Matte	Matte	Matte	Matte	Matte
75x150 cm - 29 1/2"x59"	± 9 mm	Matte	Matte	Matte	Matte	Matte
60x120 cm - 23 5/8"x47 1/4"	± 9 mm	Matte	Matte	Matte	Matte	Matte
75x75 cm - 29 1/2"x29 1/2"	± 9 mm	Matte	Matte	Matte	Matte	Matte
37,5x75 cm - 14 3/4"x29 1/2"	± 9 mm	Matte	Matte	Matte	Matte	Matte
60x60 cm - 23 5/8"x23 5/8"	± 9 mm	Matte	Matte	Matte	Matte	Matte
30x60 cm - 11 3/4"x23 5/8"	± 9 mm	Matte	Matte	Matte	Matte	Matte

**Outdoor and Wet Areas**

120x120 cm - 47 1/4"x47 1/4"	± 9 mm	Grip	Grip	Grip	Grip	Grip
120x120 cm - 47 1/4"x47 1/4"	± 20 mm		Textured	Textured	Textured	Textured

**Destination of use**



**Anti-slip**

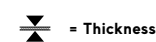
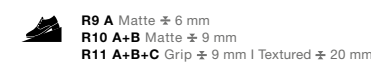

**Color-shading**

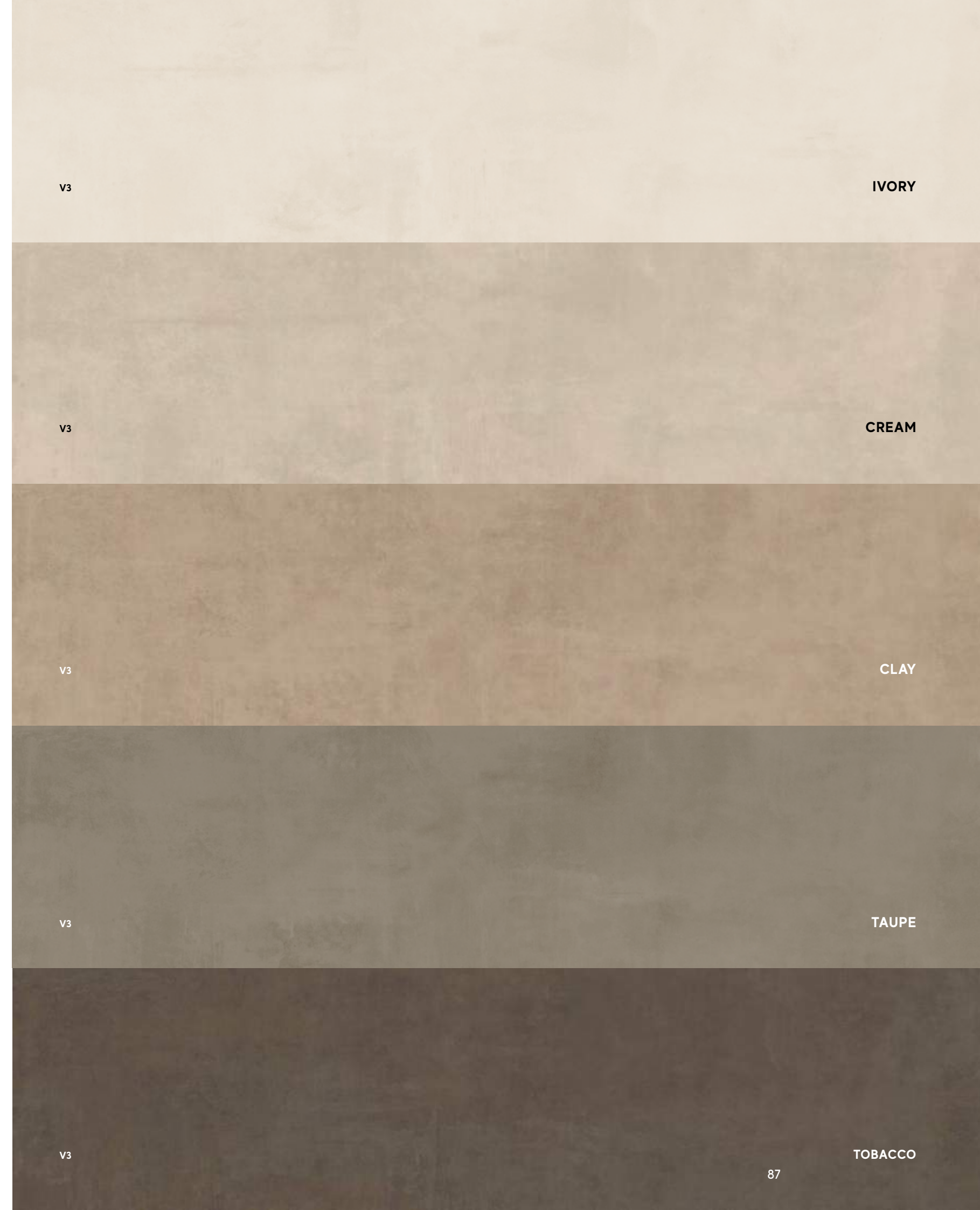
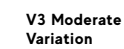

INDEX

OVERVIEW

SPACES

RANGE

TECH. SPECS

IVORY

CREAM

CLAY

TAUPE

TOBACCO

V3

V3

V3

V3

V3



BOOST PRO  
**Porcelain tile decors**

**Boost Pro Paint** ± 6 mm ■  
 120x278 cm - 47<sup>1</sup>/<sub>4</sub>"x109<sup>1</sup>/<sub>2</sub>"



**Boost Pro Leaves** ± 6 mm ●  
 120x278 cm - 47<sup>1</sup>/<sub>4</sub>"x109<sup>1</sup>/<sub>2</sub>"



**Boost Pro Grove** ± 6 mm ■  
 120x278 cm - 47<sup>1</sup>/<sub>4</sub>"x109<sup>1</sup>/<sub>2</sub>"



**Boost Pro Ivory Mosaico Shapes**  
 31x33,5 cm - 12<sup>1</sup>/<sub>4</sub>"x13<sup>1</sup>/<sub>4</sub>"



**Boost Pro Cream Mosaico Shapes**  
 31x33,5 cm - 12<sup>1</sup>/<sub>4</sub>"x13<sup>1</sup>/<sub>4</sub>"



**Boost Pro Clay Mosaico Shapes**  
 31x33,5 cm - 12<sup>1</sup>/<sub>4</sub>"x13<sup>1</sup>/<sub>4</sub>"



**Boost Pro Taupe Mosaico Shapes**  
 31x33,5 cm - 12<sup>1</sup>/<sub>4</sub>"x13<sup>1</sup>/<sub>4</sub>"



**Boost Pro Tobacco Mosaico Shapes**  
 31x33,5 cm - 12<sup>1</sup>/<sub>4</sub>"x13<sup>1</sup>/<sub>4</sub>"

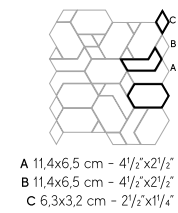

**Boost Pro Ivory Mosaico Hex Olive** ●  
 25x28,5 cm - 9<sup>7</sup>/<sub>8</sub>"x11<sup>1</sup>/<sub>4</sub>"



**Boost Pro Cream Mosaico Hex Blue** ●  
 25x28,5 cm - 9<sup>7</sup>/<sub>8</sub>"x11<sup>1</sup>/<sub>4</sub>"



**Boost Pro Taupe Mosaico Hex Coffee** ●  
 25x28,5 cm - 9<sup>7</sup>/<sub>8</sub>"x11<sup>1</sup>/<sub>4</sub>"

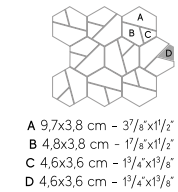

**Boost Pro Ivory Mosaico Matt**  
 30x30 cm - 11<sup>3</sup>/<sub>4</sub>"x11<sup>3</sup>/<sub>4</sub>"



**Boost Pro Cream Mosaico Matt**  
 30x30 cm - 11<sup>3</sup>/<sub>4</sub>"x11<sup>3</sup>/<sub>4</sub>"



**Boost Pro Clay Mosaico Matt**  
 30x30 cm - 11<sup>3</sup>/<sub>4</sub>"x11<sup>3</sup>/<sub>4</sub>"



**Boost Pro Taupe Mosaico Matt**  
 30x30 cm - 11<sup>3</sup>/<sub>4</sub>"x11<sup>3</sup>/<sub>4</sub>"



**Boost Pro Tobacco Mosaico Matt**  
 30x30 cm - 11<sup>3</sup>/<sub>4</sub>"x11<sup>3</sup>/<sub>4</sub>"

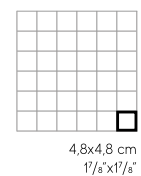
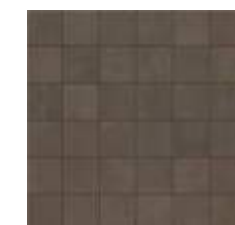

■ The production process does not guarantee the presence of the exact sequence of the graphics inside the packaging. / Il processo produttivo non garantisce la presenza dell'esatta sequenza delle grafiche all'interno dell'imballo. / Le processus de fabrication ne garantit pas la présence de la séquence exacte des graphismes à l'intérieur de l'emballage. / Der Produktionsprozess garantiert nicht die exakte Sequenz der Grafiken in der Verpackung. / El proceso de producción no garantiza la presencia de la secuencia exacta de los gráficos dentro del embalaje. / Процесс производства не обеспечивает наличие точно совпадающих рисунков поверхности внутри упаковки.

● The use of a common mild detergent is recommended. Avoid using acidic or alkaline products, waxes, steel wool, or abrasives. / Si consiglia l'utilizzo di un comune detergente neutro. Evitare l'utilizzo di prodotti acidi o alcalini, ceranti, pagliette di metallo o abrasive. / Nous vous conseillons d'utiliser des détergents neutres courants. Éviter l'utilisation de cires et de produits acides ou alcalins, ainsi que les pailles métalliques ou abrasives. / Es empfiehlt sich, ein haushaltsübliches, neutrales Reinigungsmittel zu verwenden. Saure oder alkalische Produkte, Wachs sowie Metallwolle- bzw. Scheuerschwämme sind zu vermeiden. / Recomendamos utilizar un detergente neutro común. Hay que evitar el uso de productos ácidos o alcalinos, ceras y estropajos de metal o abrasivos. / Рекомендуется чистить обычным нейтральным моющим средством. Не рекомендуется использовать кислотные, щелочные, восковые средства, а также металлические мочалки.

● The decoration can only be laid on the wall. / Il decoro si può posare solo a rivestimento. / Décor uniquement mural. / Das Dekor kann nur an der Wand verlegt werden. / La decoración se puede colocar únicamente en paredes. / Декор может быть уложен только на стену.



# BOOST PRO Wall tiles

## WHITE-BODY WALL TILES - RECTIFIED MONOCALIBER

RIVESTIMENTI IN PASTA BIANCA - RETTIFICATO MONOCALIBRO

Revêtements en pâte blanche - Rectifié mono-calibre / Weißscherbige Wandfliesen - Geschliffen einkalibrig

Revestimientos en pasta blanca - Rectificado monocolor / Настенная плитка из белой глины - Ретицированный в одном калибре

Sizes	Thickness	Surface finish	Available colors
40x80 cm - 15 <sup>3</sup> / <sub>4</sub> "x31 <sup>1</sup> / <sub>2</sub> "	± 8,5 mm	Matte	> Ivory, Cream, Clay, Powder Blue, Mustard
40x80 cm - 15 <sup>3</sup> / <sub>4</sub> "x31 <sup>1</sup> / <sub>2</sub> "	± 10 mm 3D Urban	Matte	> Ivory, Clay, Powder Blue



### Boost Pro Ivory

40x80 cm - 15<sup>3</sup>/<sub>4</sub>"x31<sup>1</sup>/<sub>2</sub>"



### Boost Pro Cream

40x80 cm - 15<sup>3</sup>/<sub>4</sub>"x31<sup>1</sup>/<sub>2</sub>"



### Boost Pro Clay

40x80 cm - 15<sup>3</sup>/<sub>4</sub>"x31<sup>1</sup>/<sub>2</sub>"



### Boost Pro Mustard

40x80 cm - 15<sup>3</sup>/<sub>4</sub>"x31<sup>1</sup>/<sub>2</sub>"



### Boost Pro Powder Blue

40x80 cm - 15<sup>3</sup>/<sub>4</sub>"x31<sup>1</sup>/<sub>2</sub>"



### Boost Pro 3D Urban Ivory

40x80 cm - 15<sup>3</sup>/<sub>4</sub>"x31<sup>1</sup>/<sub>2</sub>"



### Boost Pro 3D Urban Clay

40x80 cm - 15<sup>3</sup>/<sub>4</sub>"x31<sup>1</sup>/<sub>2</sub>"



### Boost Pro 3D Urban Powder Blue

40x80 cm - 15<sup>3</sup>/<sub>4</sub>"x31<sup>1</sup>/<sub>2</sub>"



## Wall tile decors

### Boost Pro Ivory

Minibrick Pro Olive  
29,7x33,3 cm - 11<sup>5</sup>/<sub>8</sub>"x13<sup>1</sup>/<sub>4</sub>"



### Boost Pro Cream

Minibrick Pro Blue  
29,7x33,3 cm - 11<sup>5</sup>/<sub>8</sub>"x13<sup>1</sup>/<sub>4</sub>"



### Boost Pro Clay

Minibrick Pro Coffee  
29,7x33,3 cm - 11<sup>5</sup>/<sub>8</sub>"x13<sup>1</sup>/<sub>4</sub>"



### Boost Pro Mustard

Minibrick Pro Yellow  
29,7x33,3 cm - 11<sup>5</sup>/<sub>8</sub>"x13<sup>1</sup>/<sub>4</sub>"



### Boost Pro Powder Blue

Minibrick Pro Ocean  
29,7x33,3 cm - 11<sup>5</sup>/<sub>8</sub>"x13<sup>1</sup>/<sub>4</sub>"

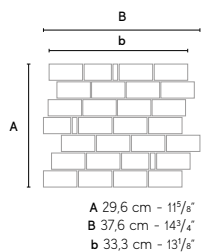

### Color-shading

V2 Slight Variation > all colors



BOOST WORLD  
**Range Summary**

**Porcelain tiles**



	± 6 mm	Matte			Matte
160x320 cm - 63"x126"	± 6 mm	Matte			Matte
160x160 cm - 63"x63"	± 6 mm	Matte			Matte
120x278 cm - 47 1/4"x109 1/2"	± 6 mm	Matte	Matte	Matte	Matte
120x240 cm - 47 1/4"x94 1/2"	± 9 mm	Matte	Matte	Matte	Matte
120x120 cm - 47 1/4"x47 1/4"	± 6 mm	Matte	Matte	Matte	Matte
	± 9 mm	Matte	Matte	Matte	Matte
75x150 cm - 29 1/2"x59"	± 9 mm	Matte	Matte	Matte	Matte
60x120 cm - 23 5/8"x47 1/4"	± 9 mm	Matte	Matte	Matte	Matte
75x75 cm - 29 1/2"x29 1/2"	± 9 mm	Matte	Matte	Matte	Matte
37,5x75 cm - 14 3/4"x29 1/2"	± 9 mm	Matte	Matte	Matte	Matte
60x60 cm - 23 5/8"x23 5/8"	± 9 mm	Matte	Matte	Matte	Matte
30x60 cm - 11 3/4"x23 5/8"	± 9 mm	Matte	Matte	Matte	Matte

**Outdoor and Wet Areas**

120x120 cm - 47 1/4"x47 1/4"	± 9 mm	Grip	Grip	Grip	Grip
120x240 cm - 47 1/4"x94 1/2"	± 20 mm	Textured		Textured	
120x120 cm - 47 1/4"x47 1/4"	± 20 mm	Textured		Textured	Textured
60x120 cm - 23 5/8"x47 1/4"	± 20 mm	Textured		Textured	Textured
90x90 cm - 35 3/8"x35 3/8"	± 20 mm	Textured		Textured	Textured
60x60 cm - 23 5/8"x23 5/8"	± 20 mm	Textured		Textured	Textured

**Slabs for Furniture**

162x324 cm - 63 3/4"x127 1/2"	± 6 mm	Matte			Matte
> Non rectified - non rettificato	± 12 mm	Matte			Matte
	± 20 mm				Matte

**Wall tiles**



40x80 cm - 15 3/4"x31 1/2"	± 8,5 mm	Matte	Matte	Matte	Matte	Matte
40x80 cm - 15 3/4"x31 1/2" 3D Urban	± 10 mm	Matte	Matte	Matte		

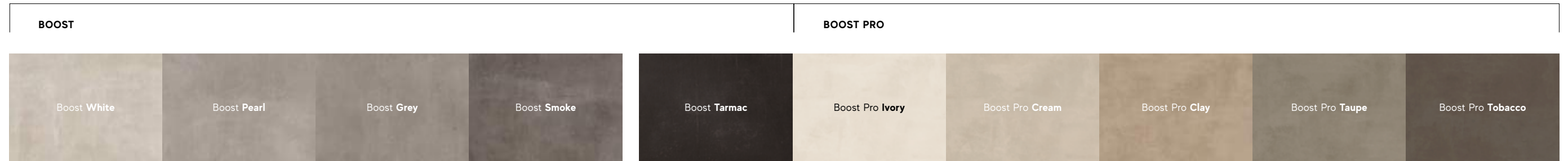



## BOOST PRO Trim tiles

### INDOOR TRIM TILES

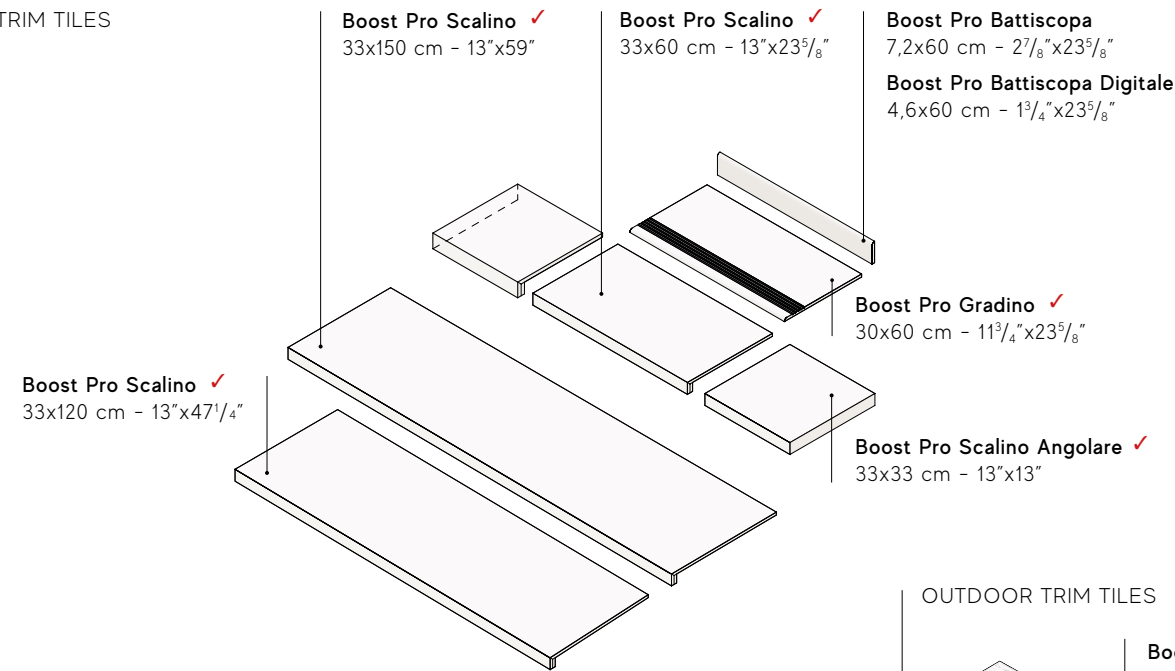

Boost Pro Battiscopa Sagomato Matt Sx/Dx ✓  
7,2x30 cm - 2<sup>7</sup>/<sub>8</sub>"x11<sup>3</sup>/<sub>4</sub>"

✓ These parts are supplied to order / I pezzi sono disponibili su ordinazione

### Outdoor trim tiles ± 20 mm



Available in / Disponibile in:

\* Cream, Clay, Taupe, Tobacco

✓ These parts are supplied to order / I pezzi sono disponibili su ordinazione

◆ Right-left angular elements are available / Sono disponibili gli elementi angolari dx/sx

### Wall trim tiles

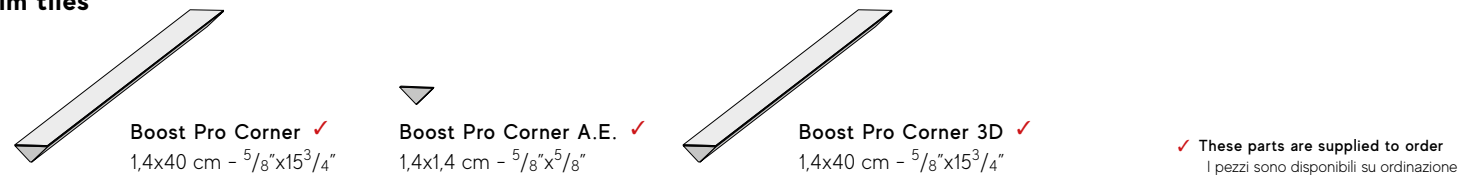

### Porcelain tiles ± 20 mm

For further details on the 20mm thick products, related trim pieces and installation systems - in particular for recommendations and precautions during installation- please refer to the Outdoor Design section on the Atlas Concorde website or to the Outdoor Design catalogue. Per dettagli sul prodotto e sui relativi pezzi speciali in 20mm di spessore, per i sistemi di posa e, in particolare, per raccomandazioni, accorgimenti e precauzioni in fase di posa e progettazione, si raccomanda di prendere visione del catalogo Outdoor Design e della sezione Outdoor Design del sito Atlas Concorde. / Pour plus de renseignements sur le produit, les pièces spéciales de 20mm d'épaisseur et sur les systèmes de pose, ainsi que pour tous conseils et recommandations et précautions d'emploi pendant la pose ou en phase de conception, nous vous recommandons de lire le catalogue Outdoor Design et de consulter la section Outdoor Design sur le site d'Atlas Concorde. / Bitte beachten Sie die detaillierten Informationen zum Produkt und zu den zugehörigen Formteilen in 20mm Stärke, zu den Verlegesystemen sowie vor allem die Empfehlungen, Tipps und bei der Planung und Verlegung zu beachtenden Vorsichtsmaßnahmen, die im Katalog Outdoor Design sowie im Bereich Outdoor Design der Atlas Concorde-Website aufgeführt sind. / Para mayor información sobre el producto y sus relativas piezas especiales de 20mm de grosor, para los sistemas de colocación, y en particular, para las recomendaciones, cautelas y precauciones en la fase de colocación y diseño, se recomienda consultar el catálogo Outdoor Design y la sección Outdoor Design del sitio Atlas Concorde. / Подробнее о плитках и о специальных элементах толщиной 20мм, о системах монтажа, о мерах предосторожности при проектировании и укладке можно узнать в каталоге Outdoor Design и в разделе Outdoor Design на сайте Atlas Concorde.



## THANKS TO

FANTINI  
www.fantini.it

BERTOCCI  
www.bertocci.it

BOTTEGANOVE  
www.botteganove.it

bross  
www.bross-italy.com

THE MALE TOOLS & Co.  
DEPOT  
www.depotmaletools.com

Tognana  
www.tognana.com

fiorirà un giardino®  
www.fioriraungiardino.com

Enrico Sironi  
www.sironienrico.it

laFABBRICA  
delLINO  
www.lafabbricadellino.com

CIPi  
www.cipitaly.it

cielo  
www.ceramicacielo.it

ZEVA  
www.zeusnoto.com

ZAVA  
www.zavaluce.it

LIVING  
DIVANI  
www.livingdivani.it

ZUCCHI  
www.zucchibassetti.com

OPINION CIATTI®  
www.opinionciatti.com

PURHO  
www.purhomilano.it

VILLA COLLECTION  
DENMARK  
villacollectiondenmark.com

Opificio  
www.lopficio.it

### Note

For information and details relating to codes, packaging and weight it is recommended to refer to the latest pricelist. / Per le informazioni e i dati relativi a codici, imballaggi e pesi occorre sempre consultare l'ultimo listino aggiornato e in vigore. / Pour toutes informations et renseignements concernant les codes, les emballages et les poids, il y a toujours lieu de consulter le dernier tarif en vigueur et mis à jour. / Für Informationen und Daten die den Code, die Verpackung und das Gewicht betreffen bitte die aktuellste Preisliste zugrunde legen. / Para acceder a la información y a los datos relativos a códigos, embalajes y pesos hay que consultar siempre la última lista de precios actualizada y vigente. / Для информации о кодах, упаковках и весе обращайтесь к последнему действующему прайс-листу.

Colors and optical features of the materials illustrated in this catalogue are to be regarded as mere indications. / I colori e le caratteristiche estetiche dei materiali illustrati nel presente catalogo sono da ritenersi puramente indicativi. / Les coloris et les caractéristiques esthétiques des références illustrées dans le catalogue sont donnés à titre purement indicatif. / Die Farben und die ästhetischen Eigenschaften der in diesem Katalog abgebildeten Produkte sind als reine Richtwerte zu betrachten. / Los colores y las características estéticas de los materiales ilustrados en el presente catálogo deben ser considerados como puramente indicativos. / Цвета и эстетические характеристики описанных в настоящем каталоге материалов являются только ориентировочными.

Atlas Concorde reserves the right to modify any product without notice and will not be liable for any direct or indirect damage resulting from such modifications. / Atlas Concorde si riserva di modificare i prodotti senza preavviso, declinando ogni responsabilità su eventuali danni diretti o indiretti derivanti da eventuali modifiche. / Atlas Concorde se réserve le droit de modifier ses produits sans préavis et décline toute responsabilité concernant les éventuels dommages directs ou indirects qui pourraient dériver de ces modifications. / Atlas Concorde behält sich das Recht vor jederzeit und ohne vorherige Ankündigung, die Produkte zu verändern, und lehnt jede Haftung bei direkten oder indirekten Schäden ab, die von diesen Veränderungen herrühren. / Atlas Concorde se reserva el derecho de modificar los productos sin previo aviso, rechaza cualquier responsabilidad sobre eventuales daños directos o indirectos derivados de eventuales modificaciones. / Atlas Concorde оставляет за собой право изменять характеристики изделий без предварительного уведомления, отклоняя при этом любую ответственность за прямые или косвенные убытки, возникшие в результате изменений.



# PORCELAIN AND WALL TILES: A SAFE CHOICE

## RESISTANCE AND DURATION

RESISTENZA E DURATA

### Easy to maintain

Facile da mantenere



Porcelain tiles do not require any special maintenance.

Il gres porcellanato non richiede manutenzioni particolari.

### UV Resistant

Resistente ai raggi UV



Porcelain tiles maintain their colors even when exposed to continuous, direct sunlight or in contact with atmospheric agents or smog.

Il gres porcellanato rimane inalterato nei suoi colori anche se esposto alla luce diretta e continua del sole o a contatto con agenti atmosferici o smog.

### Scratch resistant

Resistente al graffio

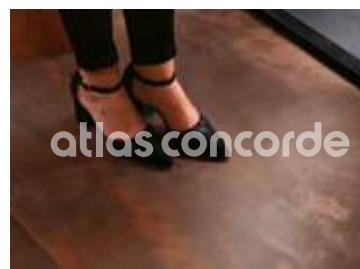

Porcelain tiles do not splinter, break or get damaged.

Il gres porcellanato non si scheggia, non si rompe e non si danneggia.

### Easy to clean

Facile da pulire



Porcelain tiles are easy to clean.

Il gres porcellanato si pulisce facilmente.

### Waterproof

Resistente all'acqua



Porcelain tiles are completely non-porous and therefore are not damaged by water or humidity.

Il gres porcellanato è completamente non poroso e non teme l'acqua e l'umidità.

### Stain resistant

Resistente alle macchie



Porcelain tiles are waterproof, no liquid can damage the surface.

Il gres porcellanato è impermeabile e nessun tipo di liquido può danneggiare la superficie.

### Resistant to chemicals

Resistente agli agenti chimici



Porcelain tiles do not stain and resist the most aggressive chemical agents.

Il gres porcellanato non si macchia e resiste agli agenti chimici più aggressivi.

### Resistant to acids

Resistente agli acidi



Porcelain tiles are resistant to acids found in food and cleaning products.

Il gres porcellanato resiste agli acidi di uso alimentare e domestico.

### Resistant to thermal shock

Resistente agli shock termici



A porcelain tile floor will not change as a result of sharp temperature fluctuations.

Un pavimento in gres porcellanato non si altera a causa di sbalzi termici.

### Frost resistant

Resistente al ghiaccio



Porcelain tiles are frost resistant and therefore are not damaged by low temperatures.

Il gres porcellanato è ingelivo e resiste alle temperature più basse.

## HEALTH

SALUTE

### Zero VOCs

Zero VOC



Porcelain tiles are intrinsically inorganic and do not emit volatile organic compounds (VOC).

Le piastrelle in gres porcellanato sono intrinsecamente inorganiche e non emettono composti organici volatili.

### Zero PVC

Zero PVC



Porcelain tiles contain no PVC, plastics or petroleum derivatives.

Il gres porcellanato è privo di PVC, plastiche o derivati del petrolio.

### Zero formaldehyde

Zero formaldeide



Porcelain tiles do not contain formaldehyde.

Il gres porcellanato non contiene formaldeide.

### Zero allergens

Zero allergeni



Porcelain tiles are inhospitable for mites, bacteria, fungi, molds, and other irritants.

Il gres porcellanato è inospitale per acari, batteri, funghi, muffe e altre sostanze irritanti.

### Prevent bacterial growth

Previene la crescita batterica



Porcelain tiles are completely hygienic and inhospitable for bacteria, mites, molds, and fungi.

Il gres porcellanato è assolutamente igienico e inospitale per i batteri, acari, muffe e funghi.



## SAFETY

SICUREZZA

### Non-slip

Antiscivolo



Porcelain tile surfaces can be made with an abrasive surface grit that can increase traction and reduce the risk of slipping.

Le superfici in gres porcellanato possono essere realizzate con una graniglia abrasiva superficiale in grado di aumentare la trazione e ridurre i rischi di scivolamento.

### Fire resistant

Resistente al fuoco



Porcelain tiles are not flammable, reduce the spread of flames, do not burn, and do not emit toxic fumes.

Le piastrelle in gres porcellanato non sono infiammabili, riducono la propagazione della fiamma, non bruciano e non emettono fumi tossici.

### Heat resistant

Resistente al calore



Porcelain tiles do not change shape at high temperatures.

Il gres porcellanato non si altera alle alte temperature.

## ENVIRONMENT

AMBIENTE

### Energy efficiency

Efficienza energetica



The high thermal inertia of porcelain tiles moderates the changes in temperature of the rooms, favoring energy savings.

L'elevata inerzia termica del gres porcellanato modera gli sbalzi di temperatura degli ambienti, favorendo il risparmio energetico.

### Ecological

Ecologico



Porcelain tiles have a low environmental impact at all stages of their production, from the raw materials to disposal and recycling.

Il gres porcellanato ha un basso impatto ambientale in tutte le fasi del suo processo industriale, dalle materie prime fino allo smaltimento e al riciclo.

### Recycling and re-use

Riciclo e riutilizzo



Porcelain tiles are made with recycled materials, last a long time, and can be re-used because they retain their original appearance.

Il gres porcellanato è realizzato con materiali di riciclo, dura a lungo e mantenendo l'aspetto originario può essere riciclato.

### Ideal for floor heating systems

Ideale per sistemi di riscaldamento a pavimento



Porcelain tiles can be effectively combined with floor heating systems.

Il gres porcellanato può essere abbinato in modo efficace a sistemi di riscaldamento a pavimento.

## WALL TILES ADDITIONAL BENEFITS

PROPRIETÀ CERAMICA  
DA RIVESTIMENTO

### Ease of installation

Facilità di lavorazione



Cuts, holes, and bevels are easily made and reduce the time it takes to lay the white body tiles.

Tagli, fori, bisellature sono facili da realizzare e rendono più veloce la posa dei rivestimenti in pasta bianca.

### Extremely easy to clean

Estrema facilità di pulizia



White body ceramic tiles can be cleaned with a simple passage of hot water or neutral detergent.

I rivestimenti ceramici in pasta bianca si puliscono con un semplice passaggio di acqua calda o detergente neutro.

While porcelain tiles are ideal for use on the floor thanks to their hardness and extreme durability, the light weight and workability of white body tiles make them ideal for use on walls: cuts and holes can be made quickly and easily, reducing installation time and costs.

Mentre il gres porcellanato è ideale per l'uso a pavimento, per la sua durezza e l'estrema resistenza, le caratteristiche di leggerezza e lavorabilità del rivestimento in pasta bianca lo rendono ideale per l'uso a parete: i tagli e i fori saranno eseguiti facilmente e velocemente, riducendo i tempi e i costi di posa.

atlas concorde



LE GRÈS CÉRAME : LE CHOIX SÛR / DAS FEINSTEINZEUG: EINE SICHERE WAHL / GRES PORCELÁNICO: LA ELECCIÓN SEGURA / КЕРАМИКА: НАДЕЖНЫЙ ВЫБОР

Résistance et longévité / Widerstandsfähigkeit und Lebensdauer / Resistencia y durabilidad / Стойкость и долговечность

## Résistance et longévité / Widerstandsfähigkeit und Lebensdauer / Resistencia y durabilidad / Стойкость и долговечность

Entretien facile / Leicht zu warten / Fácil de mantener / Простота ухода

### Entretien facile / Leicht zu warten / Fácil de mantener / Простота ухода

Le grès cérame n'exige aucun entretien particulier. / Feinsteinzeug erfordert keine besonderen Wartungsarbeiten. / El gres porcelánico no requiere particulares operaciones de mantenimiento. / Керамогранит не нуждается в особом уходе.

Résistant aux rayons UV / UV-Strahlenfest / Resistente a los rayos UV / Стойкость к УФ-излучению

### Résistant aux rayons UV / UV-Strahlenfest / Resistente a los rayos UV / Стойкость к УФ-излучению

Les coloris du grès cérame restent inaltérés même s'il est exposé à la lumière directe et continue du soleil ou au contact du smog et des agents atmosphériques. / Die Farben des Feinsteinzeugs bleiben unverändert erhalten, auch wenn es direktem und ständigem Sonnenlicht, der Witterung oder Smog ausgesetzt ist. / El gres porcelánico no se altera con el paso del tiempo, tampoco cambia su color cuando está expuesto a la luz directa y continua del sol o cuando entra en contacto con agentes climatológicos o contaminación. / Керамогранит не выцветает даже при постоянном воздействии солнечного света, атмосферных факторов, смога.

Résistant aux rayures / Kratzfestigkeit / Resistente a las rayas / Стойкость к царапинам

### Résistant aux rayures / Kratzfestigkeit / Resistente a las rayas / Стойкость к царапинам

Le grès cérame ne subit ni ébrêchures, ni cassures, ni dommages. / Feinsteinzeug splittert nicht, es zerbricht nicht und erleidet keine Beschädigungen. / El gres porcelánico no se desportilla, no se rompe y no se estropea. / Керамогранит не раскалывается, не ломается, не повреждается.

Facile à nettoyer / Leicht zu reinigen / De fácil limpieza / Легкость чистки

### Facile à nettoyer / Leicht zu reinigen / De fácil limpieza / Легкость чистки

Le grès cérame se nettoie facilement. / Feinsteinzeug kann leicht gereinigt werden. / El gres porcelánico se limpia fácilmente. / Керамогранит легко очищается.

Résistant aux taches / Fleckenfestigkeit / Resistente a las manchas / Стойкость к пятнам

### Résistant aux taches / Fleckenfestigkeit / Resistente a las manchas / Стойкость к пятнам

Le grès cérame est imperméable et aucun type de liquide ne peut endommager sa surface. / Feinsteinzeug ist wasserundurchlässig und Flüssigkeiten jeglicher Art können seine Oberfläche nicht beschädigen. / El gres porcelánico es impermeable y ningún tipo de líquido puede estropear la superficie. / Керамогранит непроницаем, и никакая жидкость не может повредить его поверхность.

### Résistant aux agents chimiques / Beständigkeit gegen Chemikalien / Resistente a los agentes químicos / Стойкость к химическим веществам

Le grès cérame ne se tache pas et résiste aux agents chimiques les plus agressifs. / Feinsteinzeug ist fleckenfest und beständig gegen die aggressivsten Chemikalien. / El gres porcelánico no se mancha y es resistente a los agentes químicos más agresivos. / Даже самые агрессивные химикаты не повреждают керамогранит и не оставляют на нем пятен.

Résistant aux acides / Beständigkeit gegen säuren / Resistente a los ácidos / Стойкость к кислотам

### Résistant aux acides / Beständigkeit gegen säuren / Resistente a los ácidos / Стойкость к кислотам

Le grès cérame résiste aux acides d'usage alimentaire et domestique. / Feinsteinzeug ist beständig gegen Säuren, die in Nahrungsmitteln oder im Haushalt verwendet werden. / El gres porcelánico es resistente a los ácidos de uso alimenticio y doméstico. / Керамогранит устойчив к кислотам, входящим в состав пищевых продуктов и средств бытовой химии.

Résistant aux écarts thermiques / Beständigkeit gegen thermoschocks / Resistente a los choques térmicos / Стойкость к перепадам температур

### Résistant aux écarts thermiques / Beständigkeit gegen thermoschocks / Resistente a los choques térmicos / Стойкость к перепадам температур

### Résistant à l'eau / Wasserfestigkeit / Resistente al agua / Стойкость к воде

Un sol en grès cérame ne subit aucune altération suite aux écarts thermiques. / Ein Feinsteinzeug-Fußboden wird von Temperaturschwankungen nicht beeinträchtigt. / El pavimento de gres porcelánico no cambia a causa de cambios bruscos de temperatura. / Напольные покрытия из керамогранита не разрушаются при перепадах температуры.

Résistant à l'eau / Wasserfestigkeit / Resistente al agua / Стойкость к воде

### Résistant à l'eau / Wasserfestigkeit / Resistente al agua / Стойкость к воде

Le grès cérame est absolument non poreux et ne craint ni l'eau ni l'humidité. / Feinsteinzeug ist absolut porös und fürchtet weder Wasser noch Feuchtigkeit. / El gres porcelánico no es poroso, no le penetra el agua y es resistente a la humedad. / Керамогранит – абсолютно непористый материал, поэтому не боится воды и влаги.

Résistant au gel / Frostbeständigkeit / Resistente a las heladas / Стойкость к морозам

### Résistant au gel / Frostbeständigkeit / Resistente a las heladas / Стойкость к морозам

Le grès cérame est ingélif et résiste aux températures les plus basses. / Feinsteinzeug ist frostbeständig und widersteht den niedrigsten Temperaturen. / El gres porcelánico es resistente a las heladas y a las bajas temperaturas. / Керамогранит способен противостоять морозам и низким температурам.

Santé / Gesundheit / Salud / Здоровье

Zéro allergène / Null allergene / Cero alérgenos / Ноль аллергенов

## Santé / Gesundheit / Salud / Здоровье

Zéro allergène / Null allergene / Cero alérgenos / Ноль аллергенов

### Zéro allergène / Null allergene / Cero alérgenos / Ноль аллергенов

Le grès cérame est inhospitalier vis-à-vis des acariens, bactéries, champignons, moisissures et autres substances irritantes. / Feinsteinzeug ist ungastlich für Milben, Bakterien, Pilze, Schimmel und andere Reizstoffe. / El gres porcelánico es inhóspito para los ácaros, bacterias, hongos, mohos y otras sustancias irritantes. / На поверхности керамогранита не накапливаются клещи, бактерии, грибки, плесень и другие болезнетворные микроорганизмы.

Zéro COV / Null VOC / Cero VOC / Ноль летучих органических соединений

### Zéro COV / Null VOC / Cero VOC / Ноль летучих органических соединений

Les carreaux en grès cérame sont intrinsèquement inorganiques et ne libèrent aucun composé organique volatil. / Feinsteinzeugfliesen sind von Natur aus anorganisch und setzen keine flüchtigen organischen Verbindungen frei. / Las baldosas de gres porcelánico son intrínsecamente inorgánicas y no emiten compuestos orgánicos volátiles. / Керамогранит является неорганическим материалом и не выделяет летучих органических соединений.

Zéro formaldéhyde / Null formaldehyd / Cero formaldehído / Ноль формальдегида

### Zéro formaldéhyde / Null formaldehyd / Cero formaldehído / Ноль формальдегида

Le grès cérame ne contient pas de formaldéhyde. / Feinsteinzeug ist formaldehydfrei. / El gres porcelánico non contiene formaldehído. / Керамогранит не содержит формальдегид.

## Zéro PVC / Null PVC / Cero PVC / Ноль ПВХ

Le grès cérame est privé de PVC, de matières plastiques et de dérivés du pétrole. / Feinsteinzeug ist frei von PVC, Kunststoffen oder Petroleumderivaten. / El gres porcelánico no contiene PVC, plástico o sustancias que derivan del petróleo. / Керамогранит не содержит ПВХ, пластиковых материалов, нефтепродуктов.

Prévention de la croissance bactérienne / Vorbeugung gegen das Wachstum von Bakterien / Previene la proliferación de bacterias / Предотвращение развития бактерий

## Il prévient la croissance bactérienne / Vorbeugung gegen das Wachstum von Bakterien / Previene la proliferación de bacterias / Предотвращение развития бактерий

Le grès cérame est absolument hygiénique et inhospitalier vis-à-vis des bactéries, acariens, moisissures et champignons. / Feinsteinzeug ist absolut hygienisch und ungastlich für Bakterien, Milben, Schimmel und Pilze. / El gres porcelánico es totalmente higiénico e inhóspito para las bacterias, ácaros, mohos y hongos. / Керамогранит абсолютно гигиеничен и препятствует развитию бактерий, клещей, плесени, грибка.

## \_\_\_\_\_

## Sécurité / Sicherheit / Seguridad / Безопасность

Antiglisse / Rutschfestigkeit / Antideslizante / Препятствование скольжению

### Antiglisse / Rutschfestigkeit / Antideslizante / Препятствование скольжению

### Antiglisse / Rutschfestigkeit / Antideslizante / Препятствование скольжению

Les surfaces en grès cérame peuvent être réalisées avec un fond superficiel abrasif en mesure d'augmenter la traction et réduire le risque de glissade. / Die Oberflächen des Feinsteinzeugs können mit die Reibung erhöhenden Splitten bereichert werden, welche die Trittsicherheit verbessern und die Gefahr von Ausrutschern mindern. / Las superficies de gres porcelánico se fabrican con una granalla abrasiva superficial en grado de aumentar la tracción y reducir los riesgos de deslizamiento. / На поверхность керамогранитной плитки в процессе изготовления может наноситься специальная абразивная крошка, которая увеличивает сцепление и снижает риск скольжения.

Résistant au feu / Feuerfestigkeit / Resistente al fuego / Огнестойкость

### Résistant au feu / Feuerfestigkeit / Resistente al fuego / Огнестойкость

Les carreaux en grès cérame sont ininflammables, ils réduisent la propagation de la flamme, ne brûlent pas et de libèrent aucune fumée toxique. / Feinsteinzfliesen sind nicht entflammbar, sie mindern die Flammenausbreitung, brennen nicht und setzen keinen toxischen Rauch frei. / Las baldosas de gres porcelánico no son inflamables, reducen la propagación de las llamas, son resistentes al fuego y no emiten humos tóxicos. / Керамогранитная плитка не воспламеняется, ограничивает распространение огня, не горит, не выделяет токсичного дыма.

Résistant à la chaleur / Wärmebeständigkeit / Resistente al calor / Термостойкость

### Résistant à la chaleur / Wärmebeständigkeit / Resistente al calor / Термостойкость

Le grès ne subit aucune altération aux températures élevées. / Feinsteinzeug wird von hohen Temperaturen nicht verändert. / El gres porcelánico no se altera con las altas temperaturas. / Керамогранит не повреждается под действием высоких температур.

## Environnement / Umwelt / Ambiente / Окружающая среда

Efficacité énergétique / Energieeffizienz / Eficiencia energética / Энергоэффективность

### Efficacité énergétique / Energieeffizienz / Eficiencia energética / Энергоэффективность

La haute inertie thermique du grès cérame modère les écarts de température à l'intérieur des pièces, en favorisant ainsi les économies d'énergie. / Die hohe Wärmeträgheit des Feinsteinzeugs reduziert starke Temperaturschwankungen in den Räumen und ermöglicht demzufolge eine Energieeinsparung. / La elevada inercia térmica del gres porcelánico modera los cambios de temperatura de los ambientes, favoreciendo el ahorro energético. / Высокая тепловая инерция керамогранита сглаживает колебания температуры в помещении, что позволяет значительно экономить энергию.

Écologique / Ökologisch / Ecológico / Экологичность

### Écologique / Ökologisch / Ecológico / Экологичность

Le grès cérame a un faible impact sur l'environnement durant toutes les phases de son processus industriel, à partir des matières premières jusqu'à l'élimination et au recyclage. / In allen Phasen seines Herstellungsprozesses verursacht das Feinsteinzeug eine geringfügige Umweltbelastung, angefangen beim Abbau der Rohstoffe bis zur Entsorgung und zum Recycling. / El gres porcelánico tiene un bajo impacto ambiental en todas las fases de su proceso industrial, dese las materias primas hasta la eliminación y el reciclaje. / Керамогранит имеет низкое воздействие на окружающую среду на всем протяжении жизненного цикла: от добычи сырья до переработки и утилизации.

Recyclage et réutilisation / Recycling und wiederverwertung / Reciclaje y reutilización / Переработка и утилизация

### Recyclage et réutilisation / Recycling und wiederverwertung / Reciclaje y reutilización / Переработка и утилизация

Le grès cérame est fabriqué avec des matériaux de recyclage, il dure longtemps en maintenant son aspect d'origine et il est recyclable. / Feinsteinzeug wird aus Recycling-Material hergestellt, hat eine lange Lebensdauer, erhält sein ursprüngliches Aussehen und kann recycelt werden. / El gres porcelánico está fabricado con materiales de reciclado, es duradero al paso del tiempo y se puede reciclar manteniendo el aspecto original. / Керамогранит изготавливается из переработанных материалов, долговечен, сохраняет во времени свои первоначальные характеристики и поддается переработке.

Idéal pour les systèmes de chauffage au sol / Ideal für fussbodenheizsysteme / Indicado para los sistemas de calefacción por suelo radiante / Идеальное решение для теплого пола

Idéal pour les systèmes de chauffage au sol / Ideal für fussbodenheizsysteme / Indicado para los sistemas de calefacción por suelo radiante / Идеальное решение для теплого пола

### Idéal pour les systèmes de chauffage au sol / Ideal für fussbodenheizsysteme / Indicado para los sistemas de calefacción por suelo radiante / Идеальное решение для теплого пола

Le grès cérame peut être associé de manière efficace à des systèmes de chauffage au sol. / Feinsteinzeug ist optimal leistungsfähig in Verbindung mit Fußbodenheizsystemen. / El gres porcelánico se puede utilizar eficazmente con sistemas de calefacción por suelo radiante. / Керамогранит отлично подходит для облицовки полов с подогревом.

### PROPRIÉTÉS DE LA CÉRAMIQUE POUR REVÊTEMENTS / EIGENSCHAFTEN DER WANDFLIESEN / CARACTERÍSTICAS Y BENEFICIOS DE LA CERÁMICA PARA REVESTIMIENTO / СВОЙСТВА КЕРАМИЧЕСКОЙ ПЛИТКИ

Tandis que le grès cérame est idéal pour l'usage au sol en raison de sa dureté et de son extrême résistance, les caractéristiques de légèreté et d'usinabilité des carreaux en pâte blanche en font l'idéal pour l'usage mural : les découpes et les perçages s'effectuent facilement et rapidement, en réduisant les temps et les coûts de la pose. / Während das Feinsteinzeug dank seiner Härte und extremen Widerstandsfähigkeit ideal für die Fußbodenverlegung ist, machen die Leichtigkeit und die Verarbeitungsfreundlichkeit der weißscherbigen Wandbeläge diese ideal für Wandverlegungen: Schnitte und Bohrungen werden leicht und schnell ausgeführt, wodurch die Verlegungszeiten und -kosten sich verringern. / Si bien el gres porcelánico es indicado para su uso en pavimentos, por su dureza y máxima resistencia, el revestimiento de pasta blanca es indicado para su uso en paredes por sus propiedades de ligereza y facilidad de trabajo: se consigue una mejor facilidad y rapidez de cortes y perforación, reduciendo los tiempos y costes de colocación. / Если керамогранит, в силу своей твердости и стойкости, особенно рекомендован для полов, то такие характеристики, как небольшой вес и высокая обрабатываемость, делают плитку из белой глины идеальной для монтажа на стену: легкость и быстрая резки и сверления снижают затраты времени и денег на укладку.

Facilité de travail / Verarbeitungsfreundlichkeit / Fácil de trabajar / Легкость обработки

### Facilité de travail / Verarbeitungsfreundlichkeit / Fácil de trabajar / Легкость обработки

Les découpes, les perçages et les biseautages sont faciles à réaliser et rendent plus rapide la pose des carrelages en pâte blanche. / Schnitte, Bohrungen, Abkantungen sind leicht zu verwirklichen, daher können weißscherbige Keramikbeläge überall schneller verlegt werden. / Cortes, perforaciones y biselados se realizan fácilmente y la instalación de los revestimientos de pasta blanca se hace con rapidez. / Легкость резки, сверления, скашивания граней ускоряет процесс укладки настенной плитки из белой глины.

Nettoyage extrêmement facile / Extrem einfache Reinigung / Máxima facilidad de limpieza / Предельная простота ухода

### Nettoyage extrêmement facile / Extrem einfache Reinigung / Máxima facilidad de limpieza / Предельная простота ухода

Les carrelages céramiques en pâte blanche se nettoient simplement avec de l'eau chaude ou avec un détergent neutre. / Die weißscherbigen Keramikbeläge werden einfach durch Abwischen mit warmem Wasser oder einem neutralen Putzmittel gereinigt. / Los revestimientos cerámicos de pasta blanca se limpian pasando un trapo húmedo con agua caliente o detergente neutro. / Настенная плитка из белой глины очищается теплой водой или нейтральным моющим средством.



White-body wall tiles - Rectified monocaliber

Rivestimenti in pasta bianca - Rettificato monocalibro



Compliant with standards EN 14411 annex L group BIII  
Compliant with standards ISO 13006 annex L group BIII  
Conforme alla norma EN 14411 Appendice L gruppo BIII  
Conforme alla norma ISO 13006 Appendice L gruppo BIII

40x80 cm - 15 3/4" x 31 1/2" ± 8,5 mm  
40x80 cm - 15 3/4" x 31 1/2" ± 10 mm 3D Urban

Technical features Caratteristiche tecniche	Test Method Metodo di prova	Requirements for nominal size N Requisiti per dimensione nominale N		
		7 cm ≤ N < 15 cm (mm)	N ≥ 15 cm (%)	(mm)
<b>Length and width</b> Lunghezza e larghezza	ISO 10545-2	± 0,4 (*) Rect.	± 0,3 (*) Rect.	± 1,0 (*) Rect.
<b>Thickness</b> Spessore		± 0,5 (**)	± 10 (**)	± 0,5 (**)
<b>Straightness of sides</b> Rettilinearità degli spigoli		± 0,4 (***) Rect.	± 0,3 (***) Rect.	± 0,8 (***) Rect.
<b>Rectangularity</b> Ortogonalità		± 0,4 (****) Rect.	± 0,3 (****) Rect.	± 1,5 (****) Rect.
<b>Surface flatness</b> Planarità	ISO 10545-2	c.c. ± 0,6 Rect.	c.c. ± 0,4 Rect.	c.c. ± 1,8 Rect.
		e.c. ± 0,6 Rect.	e.c. ± 0,4 Rect.	e.c. ± 1,8 Rect.
		w. ± 0,6 Rect.	w. ± 0,4 Rect.	w. ± 1,8 Rect.
<b>Water absorption</b> (in % by mass) Massa d'acqua assorbita (come % della massa)	ISO 10545-3	Average >10%. When the average > 20%, this shall be indicated. Individual value > 9% Media >10%. Se questo valore > 20%, deve essere indicato. Valore Singolo > 9%		
<b>Breaking strength</b> Sforzo di rottura	ISO 10545-4	S ≥ 600 N		
		R ≥ 15 N/mm <sup>2</sup>		
<b>Modulus of rupture</b> Resistenza alla flessione		R ≥ 15 N/mm <sup>2</sup>		
<b>Coefficient of thermal linear expansion</b> Coefficiente di dilatazione termica lineare	ISO 10545-8	Declared value Valore dichiarato		
<b>Thermal shock resistance</b> Resistenza agli sbalzi termici	ISO 10545-9	Pass according to EN ISO 10545-1 Test superato in accordo con ISO 10545-1		
<b>Moisture expansion</b> (in mm/m) Dilatazione all'umidità (in mm/m)	ISO 10545-10	Declared value Valore dichiarato		
<b>Crazing resistance</b> Resistenza al cavillo	ISO 10545-11	Pass according to EN ISO 10545-1 Test superato in accordo con ISO 10545-1		
<b>Bond strength/adhesion for improved cementitious adhesives</b> Adesione a trazione con adesivi cementizi migliorati	EN 1348	Declared value Valore dichiarato		
<b>Reaction to fire</b> Reazione al fuoco	-	Class A1 Classe A1		
<b>Resistance to household chemicals and swimming pool salts</b> Resistenza ai prodotti chimici di uso domestico ed agli additivi per piscina	ISO 10545-13	Minimum Class B Classe minima B		
<b>Resistance to low concentrations of acids and alkalis</b> Resistenza a basse concentrazioni di acidi e alcali		Declared Class Classe dichiarata		
<b>Resistance to high concentrations of acids and alkalis</b> Resistenza ad alte concentrazioni di acidi e alcali		Declared Class Classe dichiarata		
<b>Resistance to staining</b> Resistenza alle macchie	ISO 10545-14	Minimum Class 3 Classe 3 minima		
<b>Release of dangerous substances: Cadmium (in mg/dm<sup>2</sup>) and Lead (in mg/dm<sup>2</sup>) Rilascio di sostanze pericolose: Cadmio (in mg/dm<sup>2</sup>) e Piombo (in mg/dm<sup>2</sup>)</b>	ISO 10545-15	Declared value Valore dichiarato		

(\*) The permissible deviation, in % or mm, of the average size for each tile (2 or 4 sides) from work size (WS). Deviazione ammissibile, in % oppure mm, della dimensione media di ogni piastrella (2 oppure 4 lati) dalla dimensione di fabbricazione (WS).  
(\*\*) The permissible deviation, in % or mm, of the average thickness for each tile from the work size thickness (WS). Deviazione ammissibile, in % oppure mm, dello spessore medio di ogni piastrella dallo spessore riportato nella dimensione di fabbricazione (WS).  
(\*\*\*) The maximum permissible deviation from straightness, in % or mm, related to the corresponding work sizes (WS). Deviazione massima ammissibile di rettilinearità, in % oppure mm, in rapporto alle dimensioni di fabbricazione (WS) corrispondenti.  
(\*\*\*\*) The maximum permissible deviation from rectangularity, in % or mm, related to the corresponding work sizes (WS). Deviazione massima ammissibile di ortogonalità, in % oppure mm, in rapporto alle dimensioni di fabbricazione (WS) corrispondenti.  
c.c. The maximum permissible deviation from centre curvature, in % or mm, related to diagonal calculated from the work sizes (WS). Deviazione massima ammissibile della curvatura del centro, in % oppure mm, in rapporto alla diagonale calcolata secondo le dimensioni di fabbricazione (WS).  
e.c. The maximum permissible deviation from edge curvature, in % or mm, related to the corresponding work sizes (WS). Deviazione massima ammissibile della curvatura dello spigolo, in % oppure mm, in rapporto alle dimensioni di fabbricazione (WS) corrispondenti.  
w. The maximum permissible deviation from warpage, in % or mm, related to diagonal calculated from the work sizes (WS). Deviazione massima ammissibile dello svergolamento, in % oppure mm, in rapporto alla diagonale calcolata secondo le dimensioni di fabbricazione (WS).

Wall tiles

<b>Suitable for</b> Conforme	
<b>Suitable for</b> Conforme	
<b>Suitable for</b> Conforme	
<b>Suitable for</b> Conforme	
<b>Suitable for</b> Conforme	
<b>Suitable for</b> Conforme	<b>3D WALL Not applicable</b> Non applicabile
<b>Suitable for</b> Conforme	
10% < E <sub>v</sub> ≤ 20 %	
S ≥ 600 N	
R ≥ 15 N/mm <sup>2</sup>	
≤ 7MK <sup>-1</sup>	
<b>Resistant</b> Resiste	
≤ 0,06% (0,6mm/m)	
<b>Resistant</b> Resiste	
≥ 1,0 N/mm <sup>2</sup> (Class C2 - EN 12004)	
A1	
A	
LA	
HA	
5	
≤ 0,01 mg/dm <sup>2</sup> Cd ≤ 0,1 mg/dm <sup>2</sup> Pb	

Coloured body porcelain tiles - Rectified monocaliber



Compliant with standards EN 14411 annex G group BII  
Compliant with standards ISO 13006 annex G group BII  
Conforme alla norma EN 14411 Appendice G gruppo BII  
Conforme alla norma ISO 13006 Appendice G gruppo BII

Gres porcellanato colorato in massa - Rettificato monocalibro

160x320 cm - 63"x126" ± 6 mm  
160x160 cm - 63"x63" ± 6 mm  
120x278 cm - 47 1/4"x109 1/2" ± 6 mm  
120x120 cm - 47 1/4"x47 1/4" ± 6-9 mm  
120x240 cm - 47 1/4"x94 1/2" ± 9 mm  
60x120 cm - 23 3/8"x47 1/4" ± 9 mm  
75x150 cm - 29 1/2"x59" ± 9 mm  
75x75 cm - 29 1/2"x29 1/2" ± 9 mm  
37,5x75 cm - 14 3/8"x29 1/2" ± 9 mm  
60x60 cm - 23 3/8"x23 3/8" ± 9 mm  
30x60 cm - 11 3/4"x23 3/8" ± 9 mm  
120x120 cm - 47 1/4"x47 1/4" ± 20 mm

Technical features Caratteristiche tecniche	Test Method Metodo di prova	Requirements for nominal size N / Requisiti per dimensione nominale N		
		7 cm ≤ N < 15 cm (mm)	N ≥ 15 cm (%)	(mm)
<b>Length and width</b> Lunghezza e larghezza	ISO 10545-2	± 0,9 (*) Non-rect. ± 0,4 (*) Rect.	± 0,6 (*) Non-rect. ± 0,3 (*) Rect.	± 2,0 (*) Non-rect. ± 1,0 (*) Rect.
<b>Thickness</b> Spessore		± 0,5 (**)	± 5 (**)	± 0,5 (**)
<b>Straightness of sides</b> Rettilinearità degli spigoli		± 0,8 (***) Non-rect. ± 0,4 (***) Rect.	± 0,5 (***) Non-rect. ± 0,3 (***) Rect.	± 1,5 (***) Non-rect. ± 0,8 (***) Rect.
<b>Rectangularity</b> (Measurement only on short edges when L/l ≥ 3) Ortogonalità (Misurazione da condurre solo sui lati corti quando L/l ≥ 3)		± 0,8 (****) Non-rect. ± 0,4 (****) Rect.	± 0,5 (****) Non-rect. ± 0,3 (****) Rect.	± 2,0 (****) Non-rect. ± 1,5 (****) Rect.
<b>Surface flatness</b> Planarità	ISO 10545-2	c.c. ± 0,8 Non-rect. c.c. ± 0,6 Rect.	c.c. ± 0,5 Non-rect. c.c. ± 0,4 Rect.	c.c. ± 2,0 Non-rect. c.c. ± 1,8 Rect.
		e.c. ± 0,8 Non-rect. e.c. ± 0,6 Rect.	e.c. ± 0,5 Non-rect. e.c. ± 0,4 Rect.	e.c. ± 2,0 Non-rect. e.c. ± 1,8 Rect.
		w. ± 0,8 Non-rect. w. ± 0,6 Rect.	w. ± 0,5 Non-rect. w. ± 0,4 Rect.	w. ± 2,0 Non-rect. w. ± 1,8 Rect.
<b>Water absorption</b> (in % by mass) Massa d'acqua assorbita (come % della massa)	ISO 10545-3	E <sub>v</sub> ≤ 0,5% Individual Maximum 0,6% E <sub>v</sub> ≤ 0,5% Valore massimo singolo 0,6%		
	ASTM C373-18	Requirement ANSI A137.1-2017 Water absorption max ≤ 0,5%		
<b>Breaking strength</b> Sforzo di rottura	ISO 10545-4	S ≥ 700N (for thickness < 7,5 mm - per spessore < 7,5 mm) S ≥ 1300N (for thickness ≥ 7,5 mm - per spessore ≥ 7,5 mm)		
<b>Modulus of rupture</b> Resistenza alla flessione		R ≥ 35 N/mm <sup>2</sup>		
<b>Bending strength and breaking load</b> Resistenza a flessione e al carico di rottura (4)(5)	EN 1339 Annex F	-		
<b>Impact resistance, as coefficient of restitution</b> Resistenza all'impatto, espresso come coefficiente di restituzione	ISO 10545-5	Declared value Valore dichiarato		
<b>Mohs hardness</b> Durezza Mohs	EN 101	-		
<b>Resistance to deep abrasion of unglazed tiles (removed volume)</b> Resistenza all'abrasione profonda delle piastrelle non smaltate (volume materiale asportato)	ISO 10545-6	≤ 175 mm <sup>3</sup>		
<b>Coefficient of thermal linear expansion</b> Coefficiente di dilatazione termica lineare	ISO 10545-8	Declared value Valore dichiarato		
<b>Thermal shock resistance</b> Resistenza agli sbalzi termici	ISO 10545-9	Pass according to EN ISO 10545-1 Test superato in accordo con ISO 10545-1		
<b>Moisture expansion</b> (in mm/m) Dilatazione all'umidità (in mm/m)	ISO 10545-10	Declared value Valore dichiarato		
<b>Frost resistance</b> Resistenza al gelo	ISO 10545-12	Pass according to EN ISO 10545-1 Test superato in accordo con ISO 10545-1		
<b>Bond strength/adhesion for improved cementitious adhesives</b> Adesione a trazione con adesivi cementizi migliorati	EN 1348	Declared value Valore dichiarato		
<b>Reaction to fire</b> Reazione al fuoco	-	Class A1 or A1 <sub>fl</sub> Classe A1 oppure A1 <sub>fl</sub>		
<b>Resistance to household chemicals and swimming pool salts</b> Resistenza ai prodotti chimici di uso domestico e agli additivi per piscina	ISO 10545-13	Minimum Class B Classe minima B		
<b>Resistance to low concentrations of acids and alkalis</b> Resistenza a basse concentrazioni di acidi e alcali		Declared Class Classe dichiarata		
<b>Resistance to high concentrations of acids and alkalis</b> Resistenza ad alte concentrazioni di acidi e alcali		Declared Class Classe dichiarata		
<b>Resistance to staining, for unglazed tiles</b> Resistenza alle macchie per piastrelle non smaltate	ISO 10545-14	Declared Class Classe dichiarata		
<b>Shod Ramp Test</b> Metodo della rampa "calzato"	DIN 51130	Declared value Valore dichiarato		
	<b>Barefoot Ramp Test</b> Metodo della rampa a piedi nudi	DIN 51097	Declared value Valore dichiarato	
<b>Pendulum Friction Test</b> Metodo del Pendolo	BS 7976	PTV ≥ 36 classifies the surface as "low slip risk"		
	AS 4586	Declared Classification of the new pedestrian surface materials according to the Pendulum Test		
(1)(2)	UNE-ENV 12633	Declared value Valore dichiarato		
	<b>Coefficient of friction (COF)</b> Coefficiente di attrito	B.C.R.A. Rep. CEC/81	D. M. 236/89 del 14/06/89 μ > 0,40 per elemento scivolante cuoio su pavimentazione asciutta μ > 0,40 per elemento scivolante gomma dura su pavimentazione bagnata	
<b>Dynamic coefficient of friction (DCOF)</b> Coefficiente di attrito dinamico	ANSI A137.1	ANSI A.137.1-2017 Requires a minimum value of 0.42 for level interior space expected to be walked upon when wet. (3)		

(\*) The permissible deviation, in % or mm, of the average size for each tile (2 or 4 sides) from work size (WS). Deviazione ammissibile, in % oppure mm, della dimensione media di ogni piastrella (2 oppure 4 lati) dalla dimensione di fabbricazione (WS).  
(\*\*) The permissible deviation, in % or mm, of the average thickness for each tile from the work size thickness (WS). Deviazione ammissibile, in % oppure mm, dello spessore medio di ogni piastrella dallo spessore riportato nella dimensione di fabbricazione (WS).  
(\*\*\*) The maximum permissible deviation from straightness, in % or mm, related to the corresponding work sizes (WS). Deviazione massima ammissibile di rettilinearità, in % oppure mm, in rapporto alle dimensioni di fabbricazione (WS) corrispondenti.  
(\*\*\*\*) The maximum permissible deviation from rectangularity, in % or mm, related to the corresponding work sizes (WS). Deviazione massima ammissibile di ortogonalità, in % oppure mm, in rapporto alle dimensioni di fabbricazione (WS) corrispondenti.  
c.c. The maximum permissible deviation from centre curvature, in % or mm, related to diagonal calculated from the work sizes (WS). Deviazione massima ammissibile della curvatura del centro, in % oppure mm, in rapporto alla diagonale calcolata secondo le dimensioni di fabbricazione (WS).  
e.c. The maximum permissible deviation from edge curvature, in % or mm, related to the corresponding work sizes (WS). Deviazione massima ammissibile della curvatura dello spigolo, in % oppure mm, in rapporto alle dimensioni di fabbricazione (WS) corrispondenti.  
w. The maximum permissible deviation from warpage, in % or mm, related to diagonal calculated from the work sizes (WS). Deviazione massima ammissibile dello svergolamento, in % oppure mm, in rapporto alla diagonale calcolata secondo le dimensioni di fabbricazione (WS).  
(1). Determination of slip resistance of pedestrian surfaces; it does not cover sports surfaces and road surfaces for vehicles (skid resistance). Determinazione della resistenza allo scivolamento delle superfici pedonabili; non si applica alle pavimentazioni sportive ed alle pavimentazioni stradali veicolari.  
(2). Anti-slip performance is guaranteed at the time of delivery of the product. Le prestazioni anti-slip vengono garantite al momento della consegna del prodotto.  
(3). However, tiles with a DCOF of 0.42 or greater are not necessarily suitable for all projects. The specifier shall determine tiles appropriate for specific project conditions, considering by way of example, but not in limitation, type of use, traffic, expected contaminants, expected maintenance, expected wear, and manufacturers' guidelines and recommendations."  
(4). For further details, please refer to outdoor design general catalogue. Per maggiori informazioni riferirsi al catalogo generale Outdoor Design.  
(5). Only for products with 20 mm thickness. Solo per prodotti a 20mm di spessore.  
(\*) PTV ≥ 36 Wet on demand / su richiesta  
(\*\*) P3 on demand / su richiesta  
(\*\*\*) C2 on demand / su richiesta

Porcelain tiles			
Matte ± 9 mm	Matte ± 6 mm	Grip	Outdoor paving ± 20 mm
<b>Suitable for</b> Conforme	<b>Suitable for</b> Conforme	<b>Suitable for</b> Conforme	<b>Suitable for</b> Conforme
<b>Suitable for</b> Conforme	<b>Suitable for</b> Conforme	<b>Suitable for</b> Conforme	<b>Suitable for</b> Conforme
<b>Suitable for</b> Conforme	<b>Suitable for</b> Conforme	<b>Suitable for</b> Conforme	<b>Suitable for</b> Conforme
<b>Suitable for</b> Conforme	<b>Suitable for</b> Conforme	<b>Suitable for</b> Conforme	<b>Suitable for</b> Conforme
<b>Suitable for</b> Conforme	<b>Suitable for</b> Conforme	<b>Suitable for</b> Conforme	<b>Suitable for</b> Conforme
≤ 0,1 %	≤ 0,1 %	≤ 0,1 %	≤ 0,1 %
≤ 0,5 %	≤ 0,5 %	≤ 0,5 %	≤ 0,5 %
S ≥ 1500 N	S ≥ 1000 N	S ≥ 1500 N	S ≥ 10000 N
R ≥ 40 N/mm <sup>2</sup>	R ≥ 40 N/mm <sup>2</sup>	R ≥ 40 N/mm <sup>2</sup>	R ≥ 45 N/mm <sup>2</sup>
-	-	-	≥ T11
≥ 0,55	≥ 0,55	≥ 0,55	≥ 0,55
6	6	8	8
≤ 150 mm <sup>3</sup>	≤ 150 mm <sup>3</sup>	≤ 150 mm <sup>3</sup>	≤ 150 mm <sup>3</sup>
≤ 7MK <sup>-1</sup>	≤ 7MK <sup>-1</sup>	≤ 7MK <sup>-1</sup>	≤ 7MK <sup>-1</sup>
<b>Resistant</b> Resiste	<b>Resistant</b> Resiste	<b>Resistant</b> Resiste	<b>Resistant</b> Resiste
≤ 0,01% (0,1mm/m)	≤ 0,01% (0,1mm/m)	≤ 0,01% (0,1mm/m)	≤ 0,01% (0,1mm/m)
<b>Resistant</b> Resiste	<b>Resistant</b> Resiste	<b>Resistant</b> Resiste	<b>Resistant</b> Resiste
≥ 1,0 N/mm <sup>2</sup> (Class C2 - EN 12004)	≥ 1,0 N/mm <sup>2</sup> (Class C2 - EN 12004)	≥ 1,0 N/mm <sup>2</sup> (Class C2 - EN 12004)	≥ 1,0 N/mm <sup>2</sup> (Class C2 - EN 12004)
A1 - A1 <sub>fl</sub>	A1 - A1 <sub>fl</sub>	A1 - A1 <sub>fl</sub>	A1 - A1 <sub>fl</sub>
A	A	A	A
LA	LA	LA	LA
HA	HA	HA	HA
5	5	5	5
R10	R9	R11	R11
A+B	A	A+B+C	A+B+C
≥ 36 Dry ≥ 36 Wet	(*)	≥ 36 Dry ≥ 36 Wet	≥ 36 Dry ≥ 36 Wet
Class P3	(**)	Class P4	Class P4
Class C2	(***)	Class C3	Class C3
> 0,40 Asciutto > 0,40 Bagnato	> 0,40 Asciutto > 0,40 Bagnato	> 0,40 Asciutto > 0,40 Bagnato	> 0,40 Asciutto > 0,40 Bagnato
> 0,42 Wet	> 0,42 Wet	> 0,42 Wet	> 0,42 Wet



## Green Project

### Sustainability / Sostenibilità

In the environmental and economic sciences, sustainability is defined as the condition of development capable of ensuring the satisfaction of the needs of the present generation without compromising the ability of future generations to realize their own. Several international certifications guarantee that the Atlas Concorde products meet the criteria of sustainable construction, attesting to their low impact on the ecosystem, compliance with declared standards and attention to comfort.

Nelle scienze ambientali ed economiche, la sostenibilità è definita come condizione di uno sviluppo in grado di assicurare il soddisfacimento dei bisogni della generazione presente senza compromettere la possibilità delle generazioni future di realizzare i propri. Diverse certificazioni internazionali garantiscono che i prodotti Atlas Concorde rispondono ai criteri del costruire sostenibile, attestandone il basso impatto sull'ecosistema, la conformità agli standard dichiarati e l'attenzione al comfort abitativo.

#### Certifications / Certificazioni



##### ISO 9001

In 1995 Atlas Concorde obtained ISO 9001 quality certification for its products. It is an international recognition referring to the company's entire quality system, from the receipt of raw materials to their transformation, from the distribution of the product to their placement on the market.

Sin dal 1995 Atlas Concorde ha ottenuto per i propri prodotti la certificazione di qualità ISO 9001. Si tratta di un riconoscimento internazionale riferito all'intero sistema di qualità aziendale, dall'ingresso delle materie prime alla loro trasformazione, dalla distribuzione del prodotto alla sua immissione sul mercato.

##### LEED V4

All Atlas Concorde porcelain floor and white body wall tiles can be used in projects that follow the guidelines of the GREEN BUILDING COUNCIL, which promotes the independent certification system LEED BD&C v4 (Leadership in Energy and Environmental Design, Building Design & Construction), whose parameters establish precise criteria for the design and construction of buildings that are healthy, energy efficient and with low environmental impact. All our products in porcelain stoneware and in white clay can therefore contribute to obtaining the LEED V4 rating of buildings, in relation to different areas: Sustainable Sites, Materials and Resources, Internal Environmental Quality.

Tutti i prodotti in gres porcellanato e in pasta bianca Atlas Concorde possono essere utilizzati in progetti che seguono le linee guida del GREEN BUILDING COUNCIL, che promuove il sistema di certificazione indipendente LEED BD&C v4 (Leadership in Energy and Environmental Design, Building Design & Construction), i cui parametri stabiliscono precisi criteri di progettazione e realizzazione di edifici salubri, energeticamente efficienti e a impatto ambientale contenuto. Tutti i nostri prodotti in gres porcellanato e in pasta bianca possono quindi contribuire all'ottenimento del rating LEED V4 degli edifici, relativamente diverse aree tematiche: Siti Sostenibili, Materiali e Risorse, Qualità ambientale Interna.

##### EPD

Atlas Concorde also has an EPD declaration, which attests to the environmental sustainability of its products. The EPD (Environmental Product Declaration) also assesses the life cycle of a product, from extraction to production, transport, installation, maintenance, and cleaning. Atlas Concorde's EPD declaration was certified by the independent certifying body EPD ITALY.

Atlas Concorde dispone inoltre di una dichiarazione EPD, che attesta la sostenibilità ambientale dei prodotti. Anche la EPD (Environmental Product Declaration) valuta il ciclo di vita di un prodotto, dall'estrazione all'utilizzo passando per la produzione, il trasporto, l'installazione, la manutenzione e la pulizia. La dichiarazione EPD di Atlas Concorde è stata certificata dall'ente di certificazione indipendente EPD ITALY.

##### PEF

The environmental footprint of products (PEF, Product Environmental Footprint, according to Recommendation 2013/179/EU) is a measurement that, based on various criteria, indicates the environmental performance of a product or service over its lifetime, taking into account supply chain activities: from the extraction of raw materials, to the production, use, and end of life of the product. Atlas Concorde has a verified PEF. Atlas Concorde's PEF was verified by the DNV-GL certifying body.

L'impronta ambientale dei prodotti (PEF, Product Environmental Footprint, secondo la Raccomandazione 2013/179/UE) è una misura che, sulla base di vari criteri, indica le prestazioni ambientali di un prodotto o servizio nel corso del proprio ciclo di vita, tenendo conto delle attività della catena di approvvigionamento: dall'estrazione di materie prime, alla produzione, all'uso e fine vita del prodotto. Atlas Concorde dispone di una PEF verificata. La PEF di Atlas Concorde è verificata dall'organismo di certificazione DNV-GL.

##### FDES

Atlas Concorde has also drafted an FDES environmental declaration (Fiche de déclaration environnementale et sanitaire), this also having the purpose of transparently disclosing the product's impact, covering each phase from product extraction to production and finally laying and use.

Atlas Concorde ha realizzato inoltre la dichiarazione ambientale FDES (Fiche de déclaration environnementale et sanitaire), anch'essa con lo scopo di rendicontare in modo trasparente l'impatto del prodotto, a partire dalla fase di estrazione del prodotto, passando dalla fase di produzione, fino alla posa ed all'utilizzo.

##### HPD

Atlas Concorde has a HPD (Health Product Declaration) declaration, a complete report on the health characteristics of the finished product, compiled according to the HPD standard.

Atlas Concorde dispone della dichiarazione HPD (Health Product Declaration), un report completo sulle caratteristiche di salubrità del prodotto finito, compilato secondo lo standard HPD.

##### CAM/ISO 14021

An environmental declaration according to the ISO 14021 international standard, observance of Minimum Environmental Criteria, and the adoption of sustainability policies demonstrate Atlas Concorde's attention to environmental issues and allow the inclusion of its products in Green Public Tenders.

La dichiarazione ambientale secondo lo standard internazionale ISO 14021 ed il rispetto dei requisiti dei Criteri Ambientali Minimi permette ad Atlas Concorde, grazie all'adozione di politiche di sostenibilità, di dimostrare l'attenzione alle problematiche ambientali e proporre l'inserimento dei propri prodotti negli Appalti Pubblici Verdi.

For further details, please refer to / Per ulteriori dettagli, fare riferimento a: [atlasconcorde.com](http://atlasconcorde.com)



MADE IN ITALY. MADE TO EXCEL.

#### MADE IN ITALY

The Made in Italy logo of Atlas Concorde stands for style, quality and ethics. Having firmly adhered to the Ethical Code promoted by Confindustria Ceramica, Atlas Concorde places the Made in Italy logo on all the products designed and produced in Italy, that is to say ceramic tiles, decorations and the majority of special trim tiles. Only a small amount of the latter is manufactured in Spain. Atlas Concorde products are produced using eco-friendly technologies, top quality and safe raw materials with the best working conditions guaranteed for our personnel. For these reasons, Atlas Concorde's Made in Italy is the expression of strong values such as style, design, product quality, and respect for the environment and the people who live in it.

Il marchio Made in Italy di Atlas Concorde è sinonimo di stile, qualità ed etica. Avendo aderito con convinzione al Codice Etico di Confindustria Ceramica, Atlas Concorde appone il marchio Made in Italy su tutti i prodotti studiati, progettati e realizzati in Italia, nella fattispecie tutte le piastrelle di ceramica, le decorazioni e la maggioranza dei pezzi speciali. Solo un ristretto numero di questi ultimi è fabbricato in Spagna. I prodotti Atlas Concorde sono inoltre realizzati con tecnologie rispettose dell'ambiente, utilizzando materie prime eccellenti e sicure, garantendo le migliori condizioni di lavoro. Per queste ragioni il Made in Italy di Atlas Concorde è espressione di valori forti quali stile, design, qualità del prodotto, attenzione all'ambiente e alle persone.



The Ceramics of Italy logo is an exclusive identification on ceramic products which have effectively been made in Italy by companies that are a part of the Confindustria Ceramica and who adhered to its Ethical Code. This Code, promoted and created by Confindustria Ceramica, commits all companies to communicate, clearly and with transparency, the origin of their products.

Il marchio Ceramics of Italy contrassegna esclusivamente i prodotti ceramici effettivamente realizzati in Italia da un'azienda associata a Confindustria Ceramica che ha sottoscritto il Codice Etico. Il Codice, redatto dalla stessa Confindustria Ceramica, impegna a comunicare con chiarezza l'origine dei prodotti.

[www.ceramica.info](http://www.ceramica.info)



CERAMICHE ATLAS CONCORDE S.p.A.  
Via Canaletto 141  
41042 Spezzano di Fiorano (MO) - Italia

ATLAS CONCORDE USA, Inc.  
117 Seaboard Lane - Suite F170  
Franklin, TN 37067 - USA

ATLAS CONCORDE RUSSIA  
Business centre "Meliora Place"  
Prospekt Mira 6, 129090 Moscow - Russia

[atlasconcorde.com](http://atlasconcorde.com)



Copyright 2020 by Ceramiche Atlas Concorde S.p.A.  
(Spezzano di Fiorano, MO - Italy)  
April 2020